



Turbo Air Speed up the Pace of Innovation

CAUTION!
PLEASE KEEP POWER
SWITCH ON BEFORE
OPERATING THIS EQUIPMENT

Ice Cream Merchandisers Dipping Cabinets Service Manual

Please read this manual completely before attempting to install or operate this equipment!

TIDC-26G(W)
TIDC-47G(W)
TIDC-70G(W)
TIDC-91G(W)

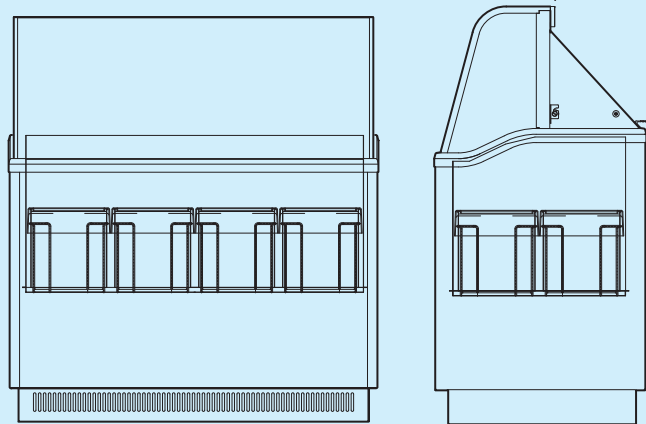

Procedure

1. Product Certificate	3 PAGE
2. Product specifications	4~ 5 PAGE
3. Product Circuitry (TIDC 26)	6 PAGE
4. Product Circuitry (TIDC 47)	7 PAGE
5. Product Circuitry (TIDC 70)	8 PAGE
6. Product Circuitry (TIDC 91)	9 PAGE
7- 1. Electrical Inspection	10 PAGE
7- 2. Electrical Inspection	11 PAGE
8. Thermostat specification	12 PAGE
9. Product Photographs	13~ 23 PAGE
10. Critical Components	24~ 30 PAGE
11. How do I exchange a part of each major cuts	31~ 35 PAGE
12. How to bridge major parts Exchange	36 PAGE
13. Comprtssor Specifications	37~ 38 PAGE
14- 1. TIDC 26 Decomposition Assembly Drawing	39 PAGE
14- 2. TIDC 26 Decomposition Assembly Drawing Component	40 PAGE
15- 1. TIDC 47 Decomposition Assembly Drawing	41 PAGE
15- 2. TIDC 47 Decomposition Assembly Drawing Component	42 PAGE
16- 1. TIDC 47 Decomposition Assembly Drawing	43 PAGE
16- 2. TIDC 47 Decomposition Assembly Drawing Component	44 PAGE
17- 1. TIDC 47 Decomposition Assembly Drawing	45 PAGE
17- 2. TIDC 47 Decomposition Assembly Drawing Component	46 PAGE

1. Product Certificate

MADE IN KOREA

MODEL TIDC-26G
 VOLTAGE 110~120V FREQUENCY 60 PH 1 AMPS 5.0
 CHARGED REFRIGERANT R-134a 5.82 oz (165g)
 DESIGN PRESSURE PSIG HIGH SIDE312, LOW SIDE140

 CONFORMS TO NSF/ANSI STD.7
 CONFORMS TO ANSI/UL STD 471
 Intertek Intertek CERTIFIED TO CAN/CSA STD C22.2 No.120

*Do not clean label with solvent

Turbo air
 REFRIGERATOR MANUFACTURER
 CARSON, CA

MADE IN KOREA

MODEL TIDC-47G
 VOLTAGE 110~120V FREQUENCY 60 PH 1 AMPS 6.5
 CHARGED REFRIGERANT R-404A 7.76 oz (220g)
 DESIGN PRESSURE PSIG HIGH SIDE312, LOW SIDE140

 CONFORMS TO NSF/ANSI STD.7
 CONFORMS TO ANSI/UL STD 471
 Intertek Intertek CERTIFIED TO CAN/CSA STD C22.2 No.120

*Do not clean label with solvent

Turbo air
 REFRIGERATOR MANUFACTURER
 CARSON, CA

MADE IN KOREA

MODEL TIDC-70G
 VOLTAGE 110~120V FREQUENCY 60 PH 1 AMPS 8.5
 CHARGED REFRIGERANT R-134a 4.94 oz (140g)
 CHARGED REFRIGERANT R-134a 5.82 oz (165g)
 DESIGN PRESSURE PSIG HIGH SIDE312, LOW SIDE140

 CONFORMS TO NSF/ANSI STD.7
 CONFORMS TO ANSI/UL STD 471
 Intertek Intertek CERTIFIED TO CAN/CSA STD C22.2 No.120

*Do not clean label with solvent

Turbo air
 REFRIGERATOR MANUFACTURER
 CARSON, CA

MADE IN KOREA

MODEL TIDC-91G
 VOLTAGE 110~120V FREQUENCY 60 PH 1 AMPS 10.5
 CHARGED REFRIGERANT R-134a 6.00 oz (170g)
 CHARGED REFRIGERANT R-404A 8.47 oz (240g)
 DESIGN PRESSURE PSIG HIGH SIDE312, LOW SIDE140



 CONFORMS TO NSF/ANSI STD.7
 CONFORMS TO ANSI/UL STD 471
 Intertek Intertek CERTIFIED TO CAN/CSA STD C22.2 No.120

*Do not clean label with solvent

Turbo air
 REFRIGERATOR MANUFACTURER
 CARSON, CA

MADE IN KOREA

MODEL TIDC-26W
 VOLTAGE 110~120V FREQUENCY 60 PH 1 AMPS 5.0
 CHARGED REFRIGERANT R-134a 5.82 oz (165g)
 DESIGN PRESSURE PSIG HIGH SIDE312, LOW SIDE140



 CONFORMS TO NSF/ANSI STD.7
 CONFORMS TO ANSI/UL STD 471
 Intertek Intertek CERTIFIED TO CAN/CSA STD C22.2 No.120

*Do not clean label with solvent

Turbo air
 REFRIGERATOR MANUFACTURER
 CARSON, CA

MADE IN KOREA

MODEL TIDC-47W
 VOLTAGE 110~120V FREQUENCY 60 PH 1 AMPS 6.5
 CHARGED REFRIGERANT R-404A 7.76 oz (220g)
 DESIGN PRESSURE PSIG HIGH SIDE312, LOW SIDE140



 CONFORMS TO NSF/ANSI STD.7
 CONFORMS TO ANSI/UL STD 471
 Intertek Intertek CERTIFIED TO CAN/CSA STD C22.2 No.120

*Do not clean label with solvent

Turbo air
 REFRIGERATOR MANUFACTURER
 CARSON, CA

MADE IN KOREA

MODEL TIDC-70W
 VOLTAGE 110~120V FREQUENCY 60 PH 1 AMPS 8.5
 CHARGED REFRIGERANT R-134a 4.94 oz (140g)
 CHARGED REFRIGERANT R-134a 5.82 oz (165g)
 DESIGN PRESSURE PSIG HIGH SIDE312, LOW SIDE140



 CONFORMS TO NSF/ANSI STD.7
 CONFORMS TO ANSI/UL STD 471
 Intertek Intertek CERTIFIED TO CAN/CSA STD C22.2 No.120

*Do not clean label with solvent

Turbo air
 REFRIGERATOR MANUFACTURER
 CARSON, CA

MADE IN KOREA

MODEL TIDC-91W
 VOLTAGE 110~120V FREQUENCY 60 PH 1 AMPS 10.5
 CHARGED REFRIGERANT R-134a 6.00 oz (170g)
 CHARGED REFRIGERANT R-404A 8.47 oz (240g)
 DESIGN PRESSURE PSIG HIGH SIDE312, LOW SIDE140

 CONFORMS TO NSF/ANSI STD.7
 CONFORMS TO ANSI/UL STD 471
 Intertek Intertek CERTIFIED TO CAN/CSA STD C22.2 No.120

*Do not clean label with solvent

Turbo air
 REFRIGERATOR MANUFACTURER
 CARSON, CA

2. Product Specifications

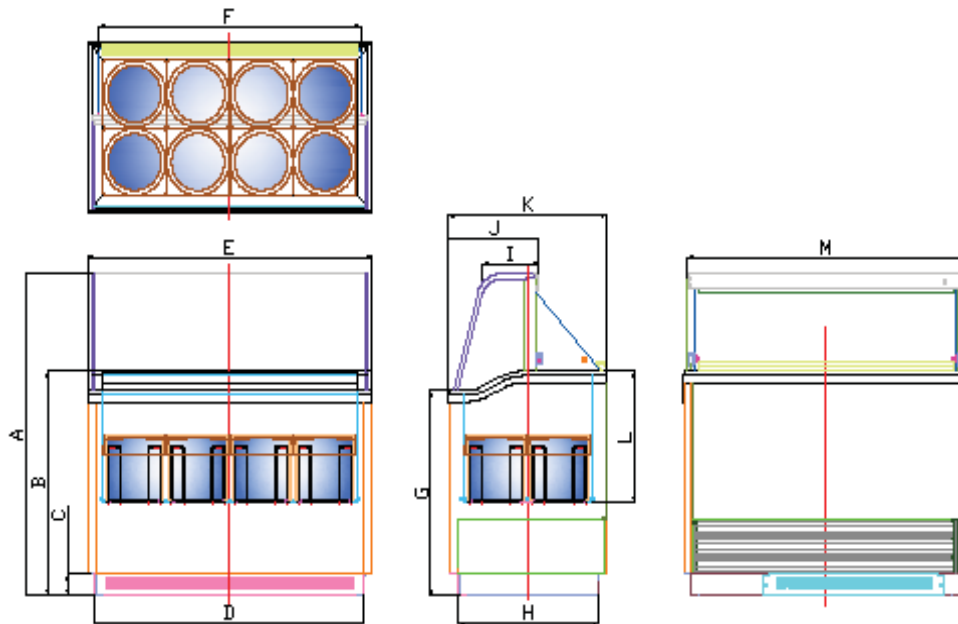

MODEL	Dimension (inch)												
	A	B	C	D	E	F	G	H	I	J	K	L	M
TIDC-26	49 17/32	34 1/2	3 9/32	23 17/32	26	22 1/4	31 17/32	23 9/32	9 1/4	14 27/32	26 1/8	20 1/4	24 23/32
TIDC-47	49 17/32	34 1/2	3 9/32	44 1/2	46 31/32	43 7/32	31 17/32	23 9/32	9 1/4	14 27/32	26 1/8	20 1/4	45 21/32
TIDC-70	49 17/32	34 1/2	3 9/32	68	70 7/16	66 23/32	31 17/32	23 9/32	9 1/4	14 27/32	26 1/8	20 1/4	69 5/32
TIDC-91	49 17/32	34 1/2	3 9/32	88 15/16	91 13/32	87 21/32	31 17/32	23 9/32	9 1/4	14 27/32	26 1/8	20 1/4	90 3/32

	Model	Overall Dimension	Capacity		Shelf #
		(D X W X H inch)	3 Gallon (12 Liter) Cans		
Model Similarity	TIDC-26*	26 1/8 X 26 X 49 17/32	4 Total	Display 4	4
				Storage 0	
	TIDC-47*	26 1/8 X 46 31/32 X 49 17/32	8 Total	Display 8	8
				Storage 0	
	TIDC-70*	26 1/8 X 70 7/16 X 49 17/32	12 Total	Display 12	12
				Storage 0	
	TIDC-91*	26 1/8 X 91 13/32 X 49 17/32	16 Total	Display 16	16
				Storage 0	

	Model	Voltage	Current	Design Pressure (psig)	Refrierant	Amount, oz.(g)	BTU/h
Ratings	TIDC-26*	110-120V~/60Hz	5.0A	H: 312, L: 140	R-134a	5.82 (165g)	1202
	TIDC-47*		6.5A	H: 312, L: 140	R-404A	7.76 (220g)	2268
	TIDC-70*		8.5A	H: 312, L: 140	R-134a	4.94 (140g)	1202
					R-134a	5.82 (165g)	1202
	TIDC-91*		10.5A	H: 312, L: 140	R-134a	6.00 (170g)	1202
					R-404A	8.47 (240g)	2268

3. Product Circuitry (TIDC-26)

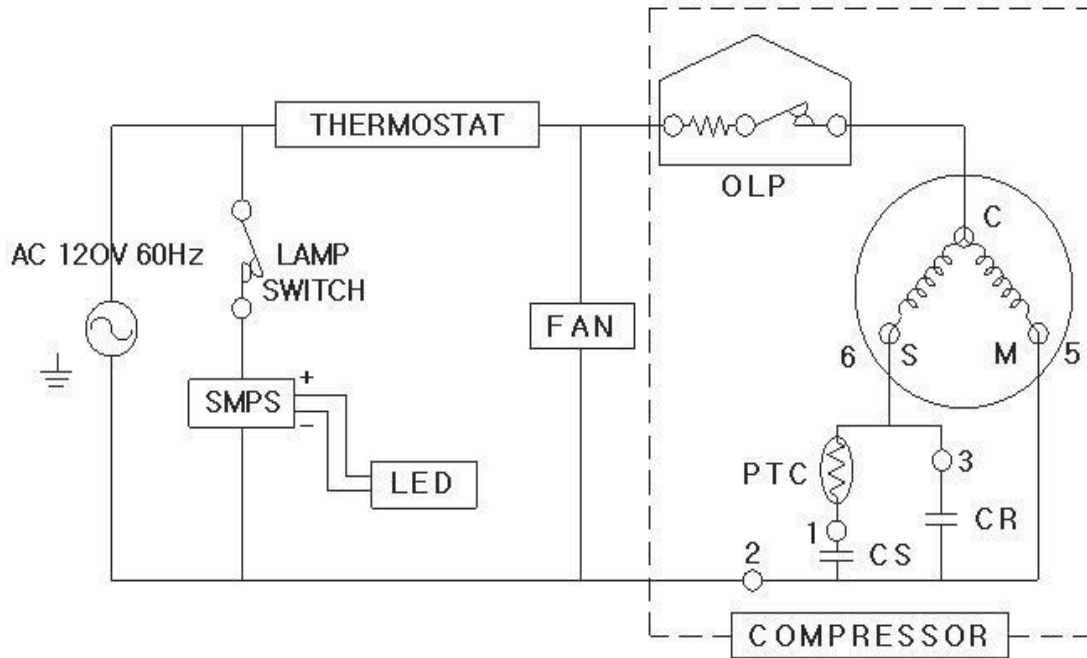

MODEL	TIDC-26G / TIDC-26W		
PRODUCT DIMENSION	INCH (DxWxH)		MM (DxWxH)
	26.10x25.98x51.46		663x660x1307
ELECTRICAL RATING	VOLLLTS (V)	FREQUENCY(Hz)	CURRENT (A)
	110-120	60	5
COMPRESSOR	MODEL	PTC	OLP
	SK1A1C-L2W	22 μ - 3PIN	4TM795TFBZZ-53
	SC	RC	
	125 μ F, 125V	12 μ F, 250V	
FAN MOTOR	MODEL	VOLLLTS (V)	AMPS (A)
	IS-4420DWSG-1(1000R)	115	0.54
SMPS	MODEL	INPUT / OUTPUT	RATED CURRENT(A)
	LPV-20-24	90~264VAC / 24VDC	0.84
LED	24V / 0.23A		
REFRIGERANT	R-134a	5.82 oz	165g

4. Product Circuitry (TIDC-47)

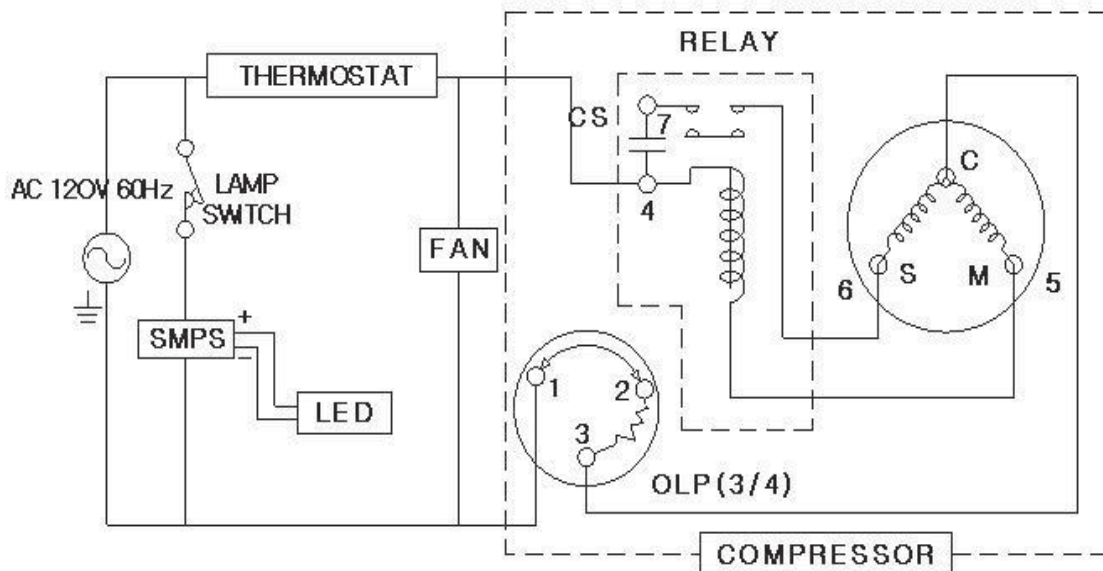

MODEL	TIDC-47G / TIDC-47W		
PRODUCT DIMENSION	INCH (DxWxH)		MM (DxWxH)
	26.10x46.93x51.46		663x1192x1307
ELECTRICAL RATING	VOLTS(V)	FREQUENCY(Hz)	CURRENT(A)
	110-120	60	6.5
COMPRESSOR	MODEL	PTC	OLP
	CAE2420Z	3ARR12KP*483	MST16AHN
	SC		
	315uF, 160V		
FAN MOTOR	MODEL	VOLTS(V)	AMPS(A)
	IS-4420DWSG-1(1000R)	115	0.54
SMPS	MODEL	INPUT / OUTPUT	RATED CURRENT(A)
	LPV-20-24	90~264VAC / 24VDC	0.84
LED	24V / 0.53A		
REFRIGERANT	R-404A	7.76 oz	220g

5. Product Circuitry (TIDC-70)

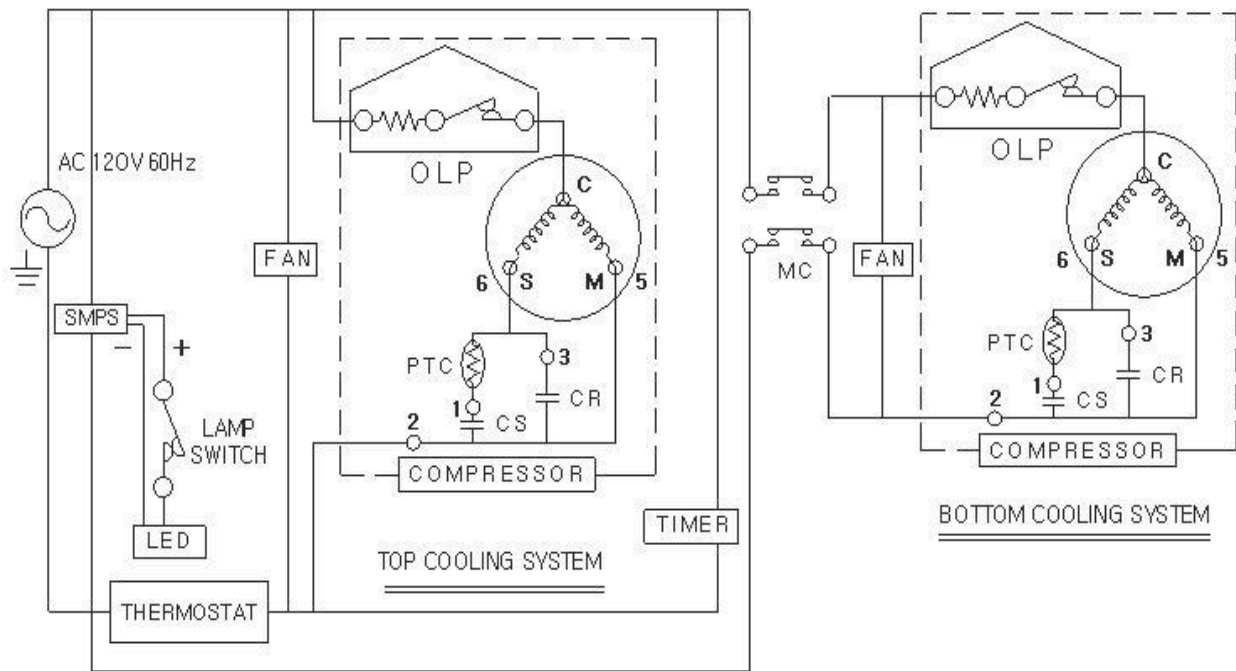

MODEL	TIDC-70G / TIDC-70W		
PRODUCT DIMENSION	INCH (DxWxH)		MM (DxWxH)
	26.10x70.39x51.46		663x1780x1307
ELECTRICAL RATING	VOLTS(V)	FREQUENCY(Hz)	CURRENT(A)
	110-120	60	8.5
COMPRESSOR (TWO COMPRESSOR COOLING SYSTEM)	MODEL	QUANTITY	PTC
	SK1A1C-L2W	2	22Ω - 3PIN
	OLP	SC	RC
	4TM795TFBZZ-53	125uF, 125V	12uF, 250V
FAN MOTOR	MODEL	QUANTITY	VOLTS / AMPS
	IS-4420DWSG-1(1000R)	2	115V / 0.54A
SMPS	MODEL	INPUT / OUTPUT	RATED CURRENT(A)
	LPV-20-24	90~264VAC / 24VDC	0.84
LED	24V / 0.87A		
REFRIGERANT	TOP COOLING SYSTEM	R-134a	5.82oz (165g)
	BOTTOM COOLING SYSTEM	R-134a	4.94oz (140g)

6. Product Circuitry (TIDC-91)

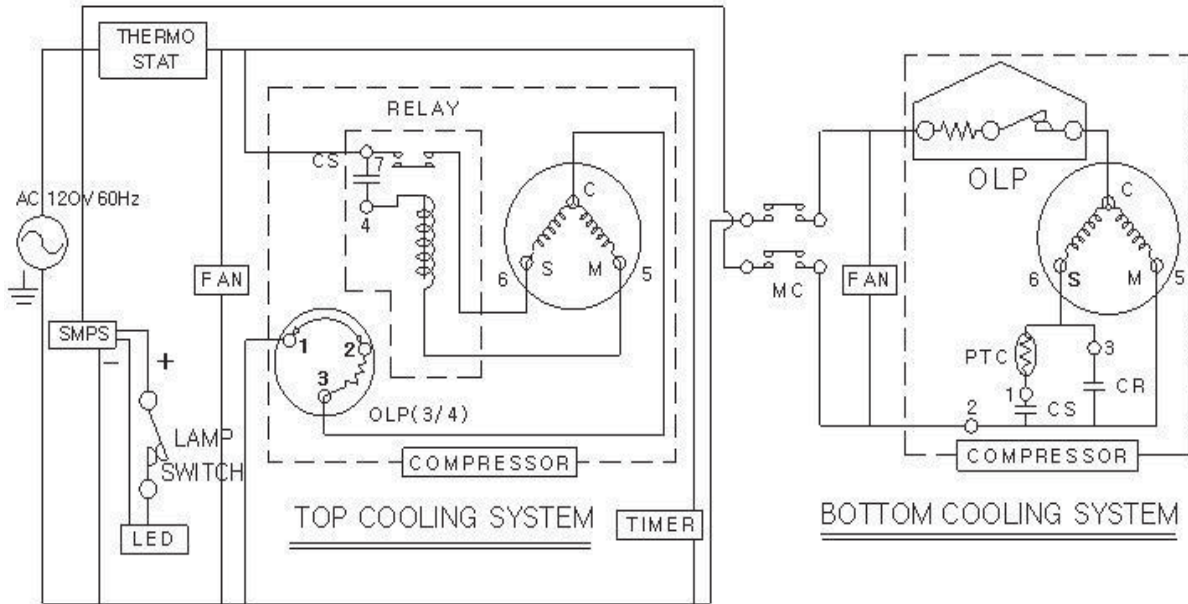

MODEL	TIDC-91G / TIDC-91W	
PRODUCT DIMENSION	INCH (DxWxH)	MM (DxWxH)
	26.10x91.34x51.46	663x2320x1307
ELECTRICAL RATING	VOLLLTS (V)	FREQUENCY(Hz)
	110-120	60
COMPRESSOR (TOP COOLING SYSTEM)	MODEL	PTC
	CAE2420Z	3ARR12KP*483
	SC	
	315?? 160V	
COMPRESSOR (BOTTOM COOLING)	MODEL	PTC
	SK1A1C-L2W	22 - 3PIN
	SC	RC
	125uF, 125V	12uF, 250V
FAN MOTOR	MODEL	QUANTITY
	IS-4420DWSG-1(1000R)	2
SMPS	MODEL	INPUT / OUTPUT
	LPV-35-24	90~264VAC / 24VDC
LED	QUANTITY : 2EA	24V / 0.53A
REFRIGERANT	TOP COOLING SYSTEM	R-404A
	BOTTOM COOLING SYSTEM	R-134a

7-1. Electrical Inspection

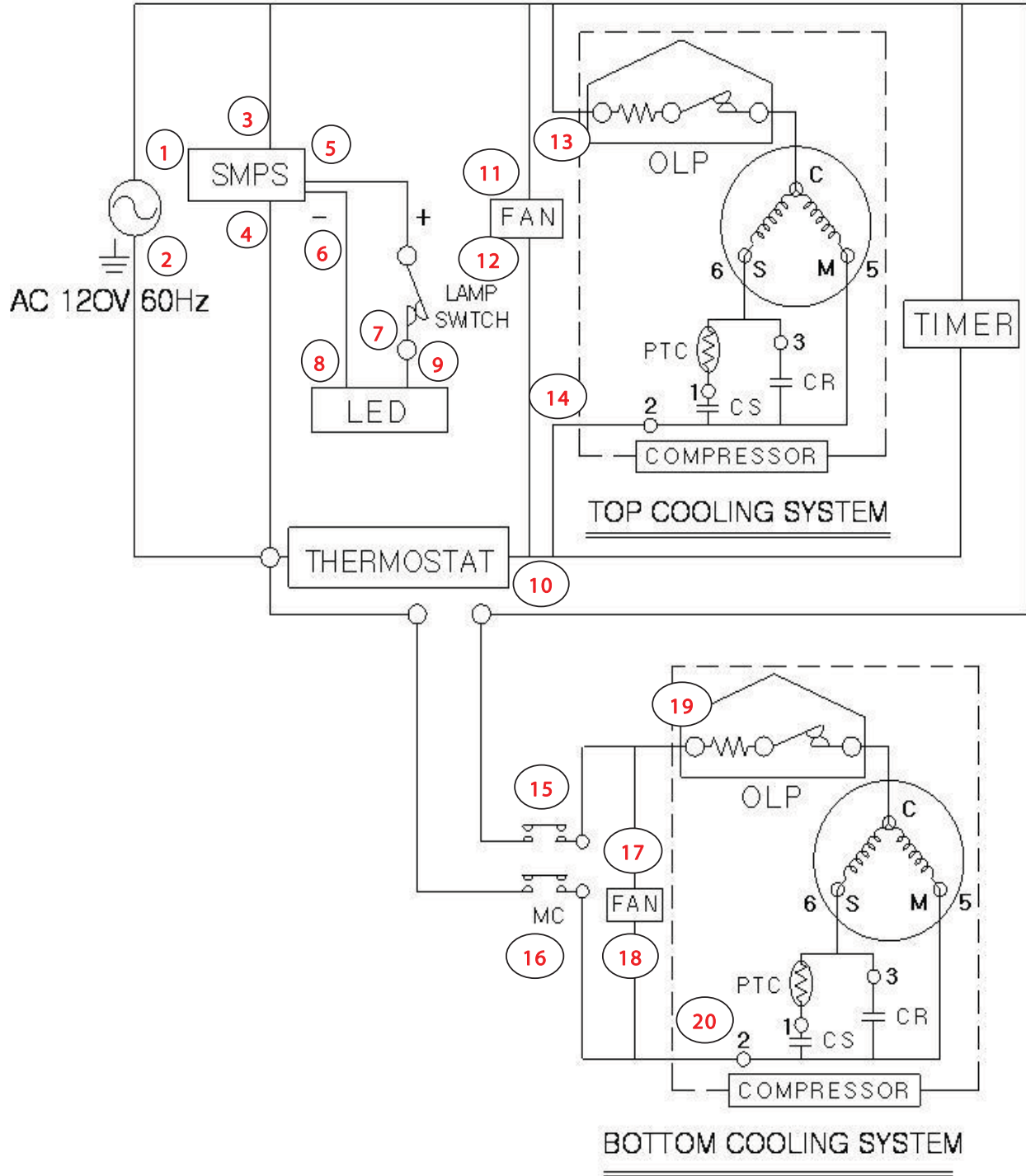

7-2. Electrical Inspection

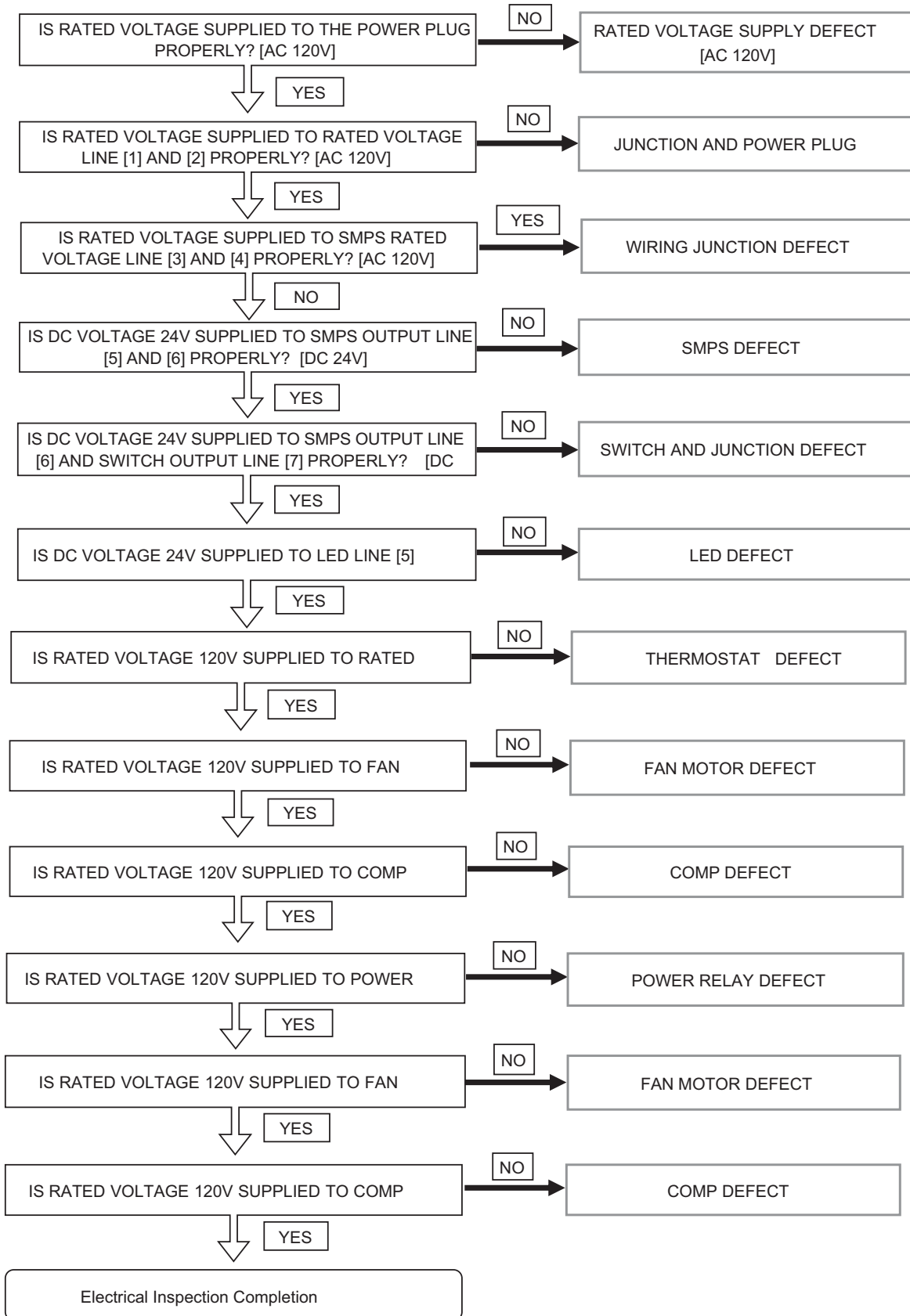

8. Thermostat Specification

OPERATION TEMPERATURE FEATURE	NOTC		COLD	NORMAL	WARM
	CONDITION				
	ON ()		(-23.5)	-20±1.5	(-15.5)
	OFF ()		(-30.5)	-27±1.5	(-22.5)
DIFF ()		-	(7)	-	
1. Operating temperature characteristics are based on two levels. 2. Numbers in brackets are reference temperature.					
RATED ELETRICITY	RATED		Power Factor COS Ø	AC	
	NONINDUCTIVE LOAD CURRENT			125V	250V
	INDUCTIVE LOAD CURRENT	Always - Current	0.75	1 - 20	1 - 20
		Net : Current	0.45	1 - 20	1 - 20
CONTACT FORM			S.P.S.T		
INSULATE RESISTANCE			MORE THAN 100MΩ IN DC 500V		
DIELECTRIC STRENGTH			STAND FOR 1 MINUTE IN AC 1500V		
CONTACT RESISTANCE			LESS THAN 50mΩ		
PRESSURIZING TYPE			G-CHARGE		
WORKABLE TEMPERATURE CONDITION			MAIN FRAME>PROBE		
VARIATION OF TEMPERATURE			MORE THAN 1 IN 1 MINUTE		
ALLOWABLE TEMPERATURE			MAIN FRAME : 70 PROBE : 80		
ENDURANCE LIMIT			200,000 TIMES		
SHAFT TURN TORQUE			COLD-WARM : 0.2~3.5Kg.cm WARM-OFF : LESS THAN 4.5Kg.cm		

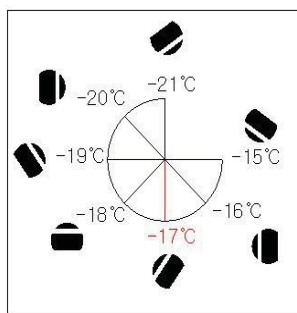
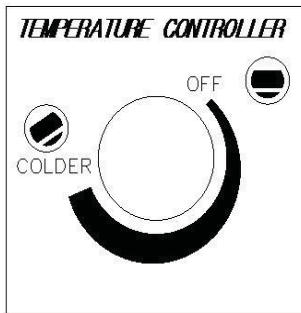
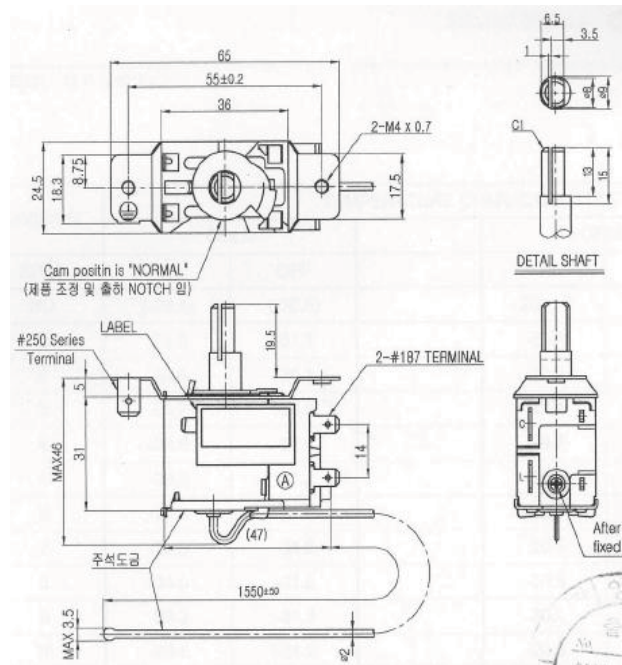

TEMPERATURE CONTROLLER WHEN COOLING COVER IS NOT



COOLING COVER

TEMPERATURE IN THE STORAGE IS LOWER ABOUT - 4 ~ - 5 WHEN YOU ADJUST COLLING COVER.

9. Product Photographs

Photo 1 - External view of model TIDC-26W



Photo 2 - External view of model TIDC-47W



<Front view>

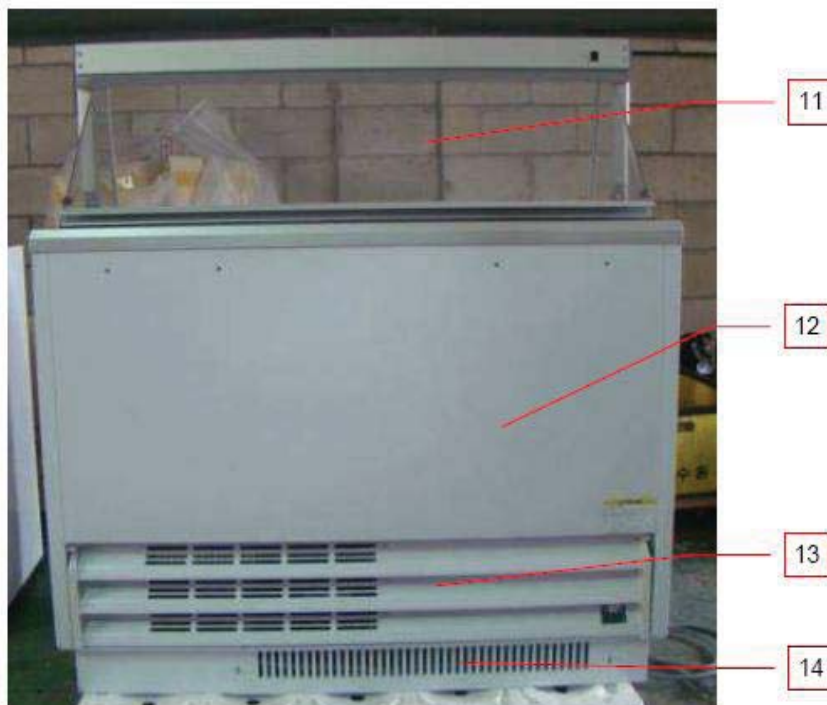

<Rear view>

Photo 3 - External view of model TIDC-70W



<Front view>



<Rear view>

19

Photo 4 - External view of model TIDC-91W



<Front view>

21

22

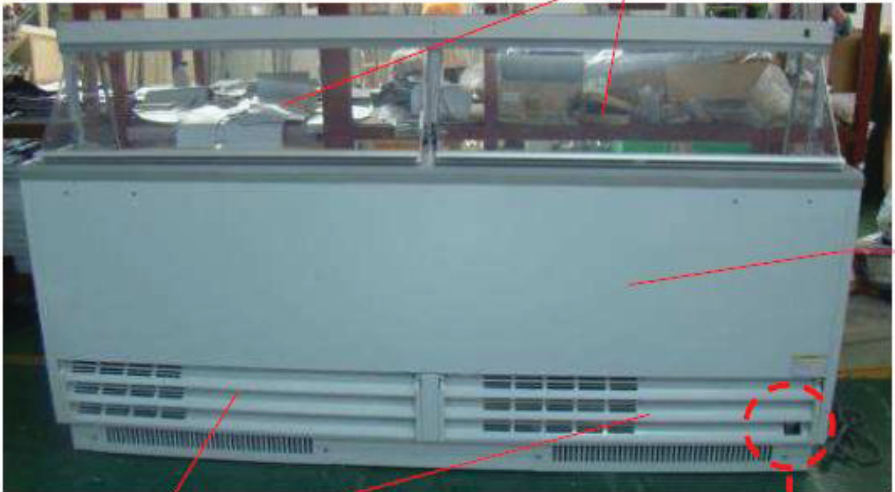

23

24

<Rear view>



Photo 5 - Side view of Ice cream dipping cabinet



Photo 6 - Marking label view of model TIDC-26W, TIDC-47W, TIDC-70W, TIDC-91W



Photo 7 - Inner enclosure view of Ice cream dipping cabinet



Photo 8 - Window Door view of Ice cream dipping cabinet

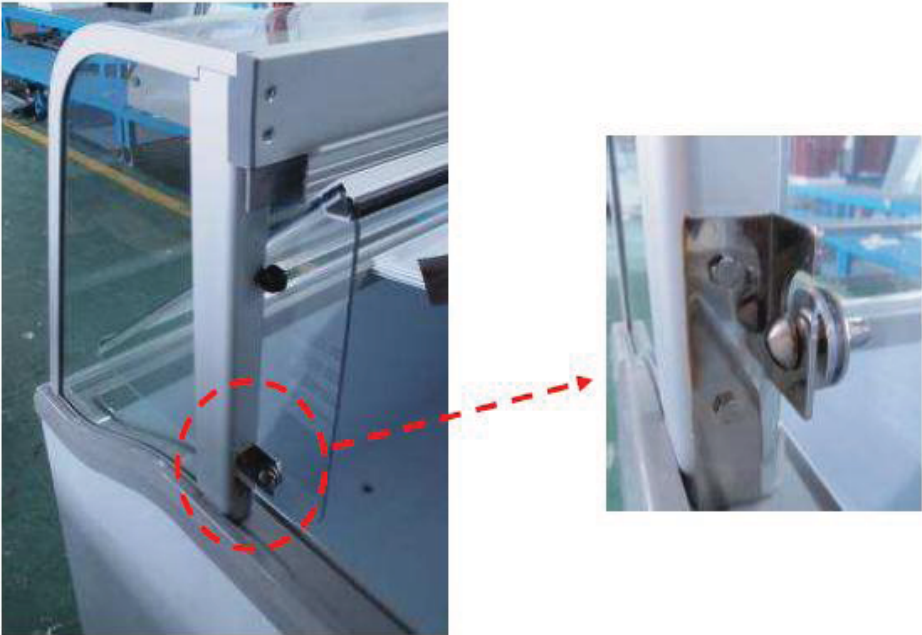

Photo 9 - Machinery compartment view of model TIDC-26W

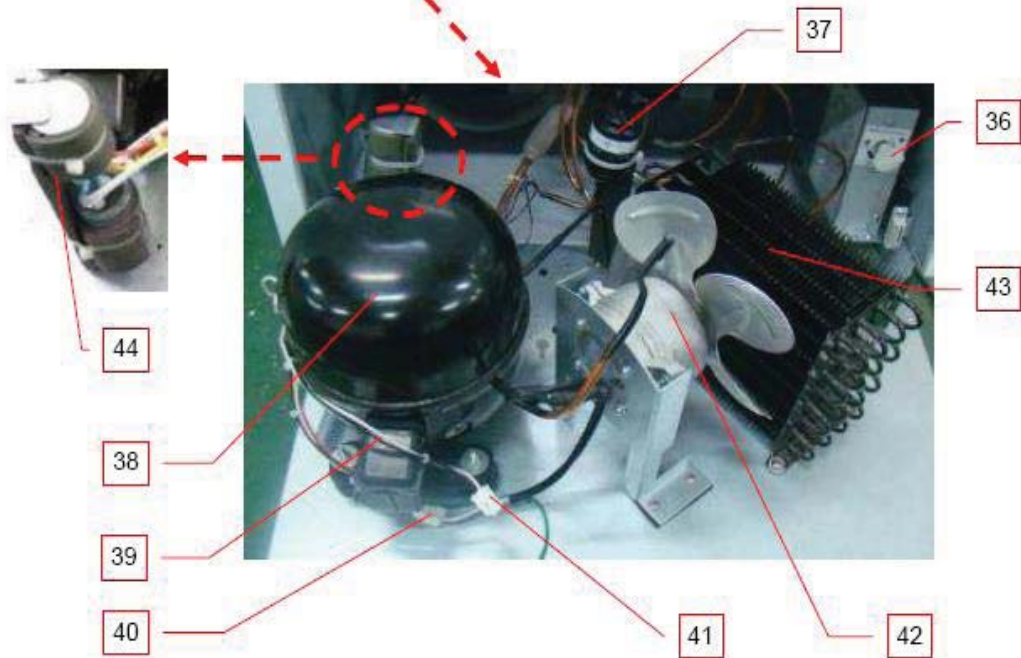
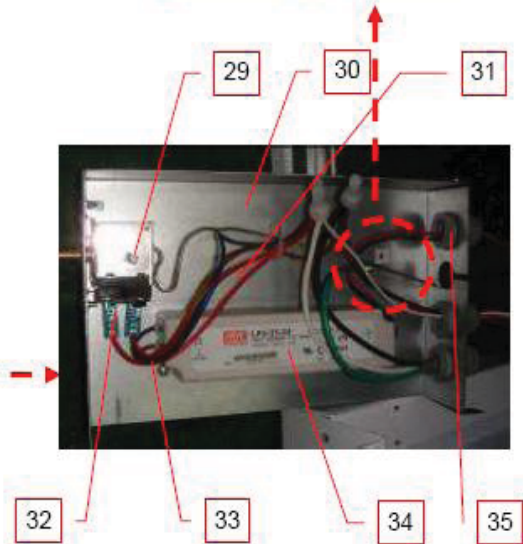
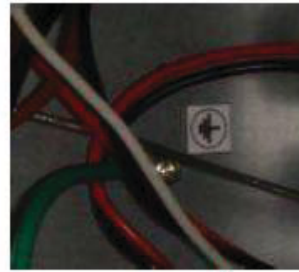

Photo 10 - Machinery compartment view of model TIDC-47W

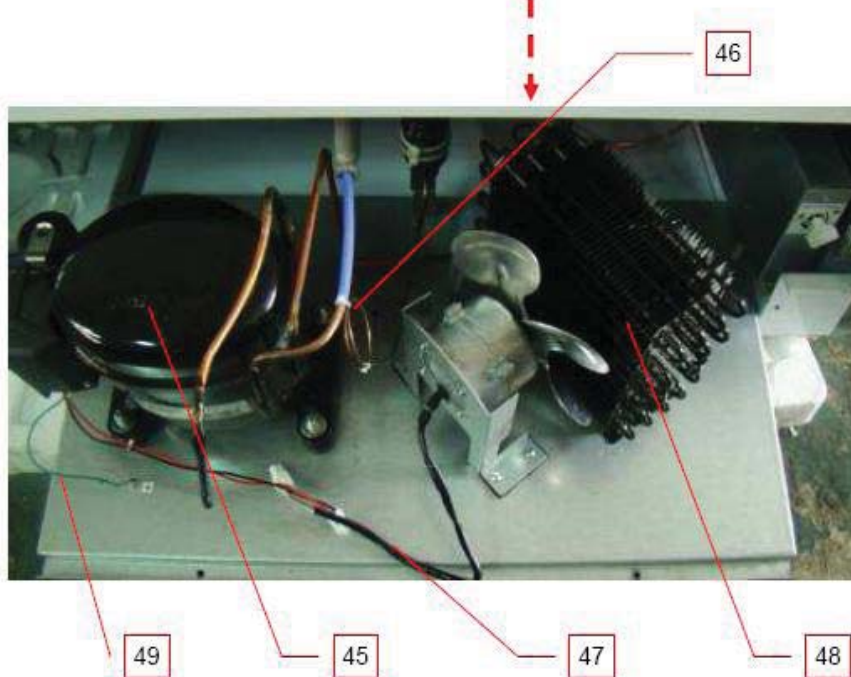

Photo 11 - Machinery compartment view of model TIDC-70W

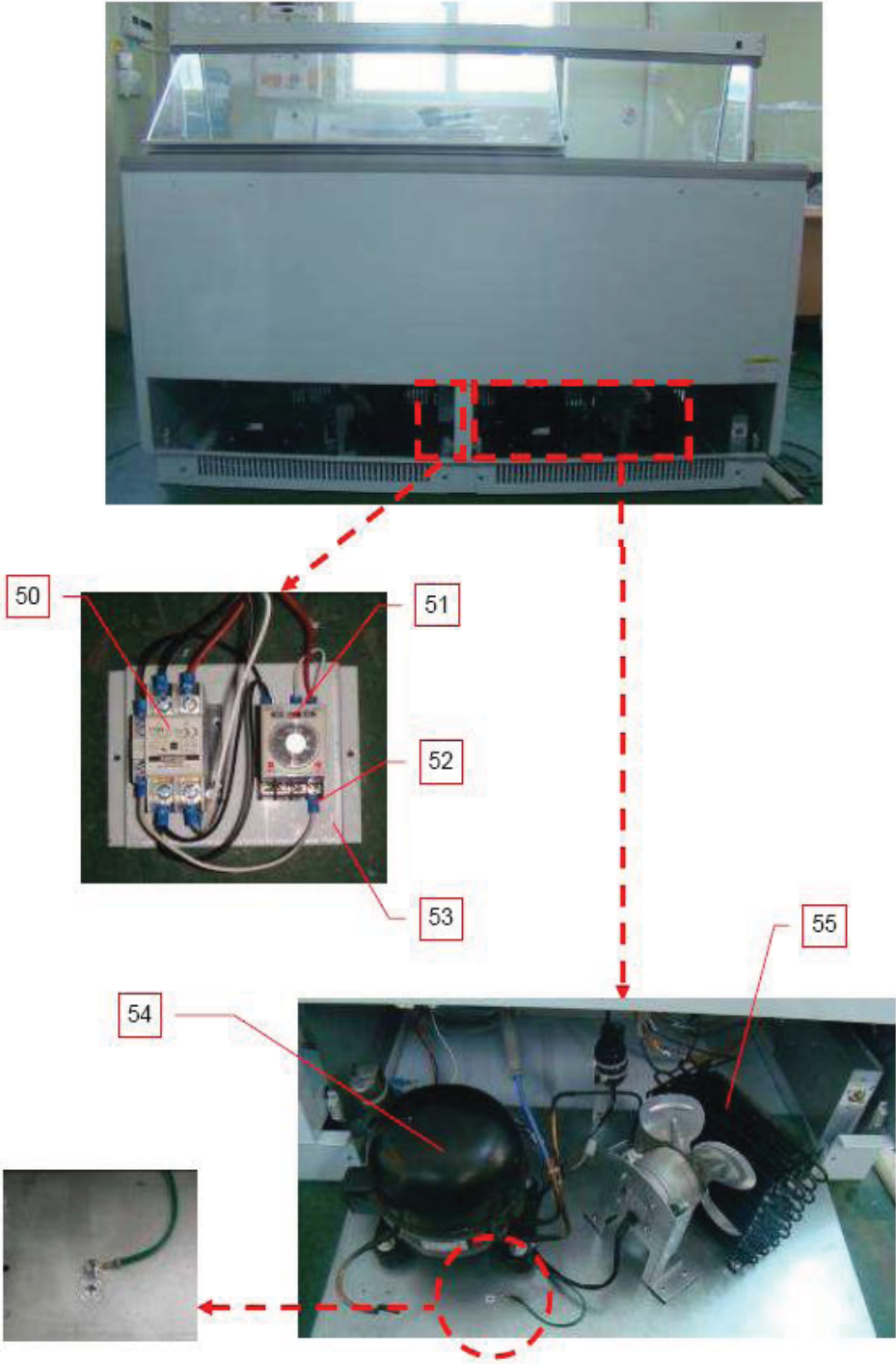
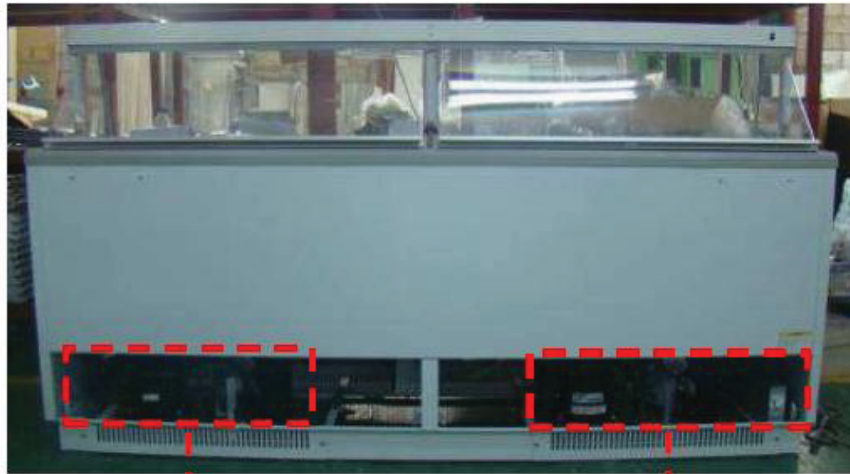

Photo 12 - Machinery compartment view of model TIDC-91W



56



57

58



59

60

Photo 13 - LED view of Ice cream dipping cabinet

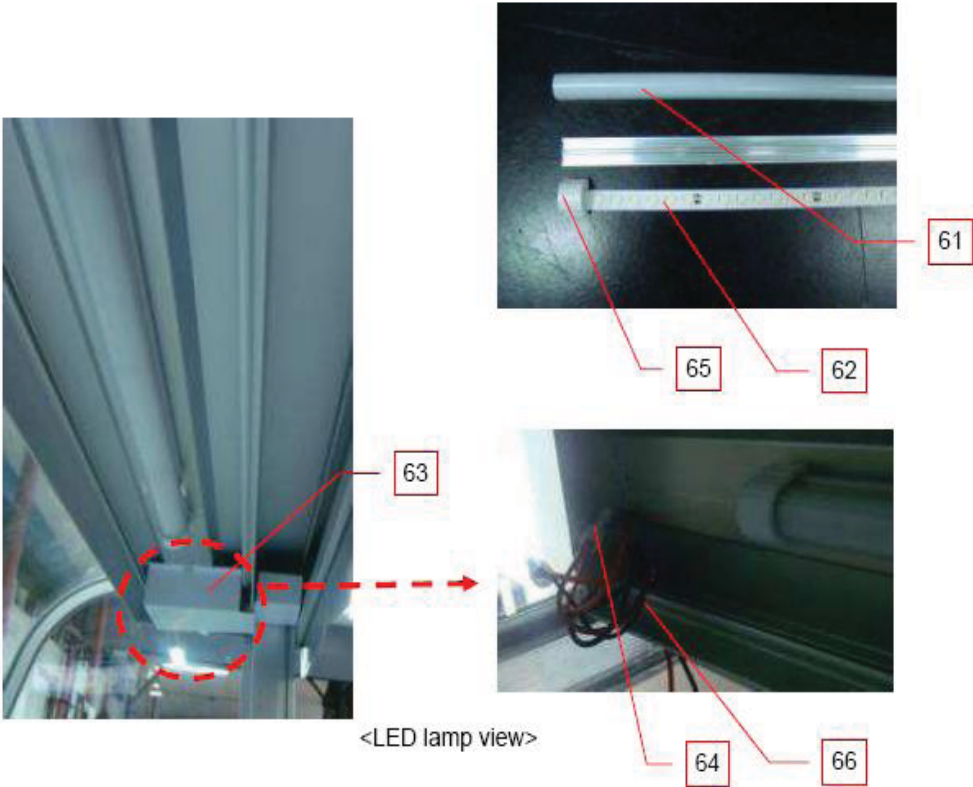
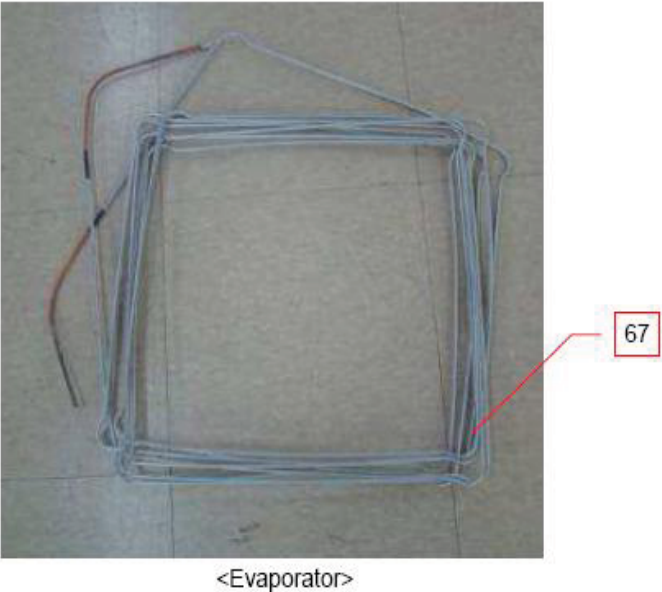

Photo 14 - Evaporator view of Ice cream dipping cabinet



10. Critical Components

4.0 Critical Components						
Photo #	Item no. ¹	Name	Manufacturer/ trademark ²	Type / model ²	Technical data and securement means	Mark(s) of conformity ³
1	1	Cabinet Window (TIDC-26W)	Dongshin Glass	Heated tempered glass	Min. thickness 6.0 mm, overall Dimension is 621 x 341 x 460 mm, secured to body frame by screws	NR
			Cheil Glass			
1	2	Front Enclosure (TIDC-26W)	POSCO	Stamped sheet steel	Min. thickness 0.7 mm, dimension is 660 x 663 mm, secured to body frame by screw	NR
			B&G Steel			
1	3	Window Door (TIDC-26W)	Samyang Corporation	3025IR	V-2, RTI(125,115,125), HWI(2), HAI(0), CTI(2), min. thickness 3.0 mm, overall dimension is 562 x 299 x 329 mm, secured to body frame by snap-in	cURus
1	4	Rear Enclosure (TIDC-26W)	POSCO	Stamped sheet steel	Min. thickness 0.7 mm, dimension is 660 x 663 mm, secured to body frame by screw	NR
			B&G Steel			
1	5	Cord Sets (all models)	Various	SJT	300 V~, 3 x 14 AWG, 105 °C, secured to side enclosure by snap bushing	UL
				NEMA 5-15P	125 V~, 15 A	
1	6	Grille (TIDC-26W)	POSCO	Stamped sheet steel	Min. thickness 0.7 mm, dimension is 585 x 215 mm, ventilating opening dimension is 5 x 539 mm, secured to body frame by screw	NR
			B&G Steel			
1	7	Rear Ventilation (TIDC-26W)	POSCO	Stamped sheet steel	Min. thickness 2.0 mm, dimension is 598 x 110 mm, ventilating opening dimension is 8 x 60 mm, secured to body frame by screws	NR
			B&G Steel			
1	8	Lamp Switch (all models)	Light Country Co., Ltd	R19A-5	125 V~, 15 A, 60 Hz, 65 °C, 6E3, secured to aluminum frame by snap in	cURus
2	9	Cabinet Window (TIDC-47W)	Dongshin Glass	Heated tempered glass	Min. thickness 6.0 mm, overall dimension is 1 153 x 341 x 460 mm, secured to body frame by screws	NR
			Cheil Glass			
2	10	Front Enclosure (TIDC-47W)	POSCO	Stamped sheet steel	Min. thickness 0.7 mm, dimension is 1 192 x 663 mm, secured to body frame by screw	NR
			B&G Steel			
2	11	Window Door (TIDC-47W)	Samyang Corporation	3025IR	V-2, RTI(125,115,125), HWI(2), HAI(0), CTI(2), min. thickness 3.0mm, overall dimension is 1 094 x 299 x 329 mm, secured to body frame by snap-in	cURus

4.0 Critical Components						
Photo #	Item no. ¹	Name	Manufacturer/ trademark ²	Type / model ²	Technical data and securement means	Mark(s) of conformity ³
2	12	Rear Enclosure (TIDC-47W)	POSCO B&G Steel	Stamped sheet steel	Min. thickness 0.7 mm, dimension is 1 192 × 663 mm, secured to body frame by screw	NR
2	13	Grille (TIDC-47W)	POSCO B&G Steel	Stamped sheet steel	Min. thickness 0.7 mm, dimension is 1 119 × 215 mm, ventilating opening dimension is 5 × 1 083 mm, secured to body frame by screw	NR
2	14	Rear Ventilation (TIDC-47W, TIDC-70W, TIDC-91W)	POSCO B&G Steel	Stamped sheet steel	Min. thickness 2.0 mm, dimension is 755 × 110 mm, ventilating opening dimension is 8 × 60 mm, secured to body frame by screws	NR
3	15	Cabinet Window (TIDC-70W)	Dongshin Glass Cheil Glass	Heated tempered glass	Min. thickness 6.0 mm, overall Dimension is 1 749 × 341 × 460 mm, secured to body frame by screws	NR
3	16	Front Enclosure (TIDC-70W)	POSCO B&G Steel	Stamped sheet steel	Min. thickness 0.7 mm, dimension is 1 788 × 663 mm, secured to body frame by screw	NR
3	17	Window Door (TIDC-70W)	Samyang Corporation	3025IR	V-2, RTI(125,115,125), HWI(2), HAI(0), CTI(2), min. thickness 3.0 mm, overall dimension of large door is 1 094 × 299 × 329 mm and overall dimension of small door is 562 × 299 × 329 mm, secured to body frame by snap-in	cURus
3	18	Rear Enclosure (TIDC-70W)	POSCO B&G Steel	Stamped sheet steel	Min. thickness 0.7 mm, dimension is 1 788 × 663 mm, secured to body frame by screw	NR
3	19	Grille (TIDC-70W)	POSCO B&G Steel	Stamped sheet steel	Min. thickness 0.7 mm, dimension is 215 × 830 mm, ventilating opening dimension is 5 × 784 mm, secured to body frame by screw	NR
4	20	Cabinet Window (TIDC-91W)	Dongshin Glass Cheil Glass	Heated tempered glass	Min. thickness 6.0 mm, overall Dimension is 2 281 × 341 × 460 mm, secured to body frame by screws	NR
4	21	Front Enclosure (TIDC-91W)	POSCO B&G Steel	Stamped sheet steel	Min. thickness 0.7 mm, dimension is 2 320 × 663 mm, secured to body frame by screw	NR
4	22	Window Door, 2 employed (TIDC-91W)	Samyang Corporation	3025IR	V-2, RTI(125,115,125), HWI(2), HAI(0), CTI(2), min. thickness 3.0mm, overall dimension is 1 094 × 299 × 329 mm, secured to body frame by snap-in	cURus
4	23	Rear Enclosure (TIDC-91W)	POSCO B&G Steel	Stamped sheet steel	Min. thickness 0.7 mm, dimension is 2 320 × 663 mm, secured to body frame by screw	NR

4.0 Critical Components						
Photo #	Item no. ¹	Name	Manufacturer/ trademark ²	Type / model ²	Technical data and securement means	Mark(s) of conformity ³
4	24	Grille (TIDC-91W)	POSCO	Stamped sheet steel	Min. thickness 0.7 mm, dimension is 1 096 x 215 mm, ventilating opening dimension is 5 x 1 050 mm, secured to body frame by screw	NR
			B&G Steel			
5	25	Side Enclosure (TIDC-26W, TIDC-47W, TIDC-70W, TIDC-91W)	POSCO	Stamped sheet steel	Min. thickness 0.7 mm, dimension is 1 307 x 663 mm, secured to body frame by screw	NR
			B&G Steel			
5	26	Snap Bushing (all models)	KAI SUH SUH Enterprise Co.,Ltd	EG11L	V-2, mounting hole 18.3 mm, outer diameter 13.2 mm, mounted to side enclosure by snap-in	URus
6	27	Label system (all models)	Shin Kwang Sealing Printing Co.	SK-400PP	Max. temperature 150 °C, min. temperature -40 °C, secured to inner enclosure by adhesive	cURus
7	28	Inner Enclosure (TIDC-26G)	POSCO	Galvanized steel	Min. thickness 0.7 mm, dimension is 660 x 540 x 535 mm, secured to body frame by screw	NR
		Inner Enclosure (TIDC-47G)			Min. thickness 0.7 mm, dimension is 1 192 x 540 x 535 mm, secured to body frame by screw	
		Inner Enclosure (TIDC-70G)	B&G Steel		Min. thickness 0.7 mm, dimension is 1 788 x 540 x 535 mm, secured to body frame by screw	
		Inner Enclosure (TIDC-91G)			Min. thickness 0.7 mm, dimension is 2 320 x 540 x 535 mm, secured to body frame by screw	
9	29	Thermostat (all models)	Shin Han Electro-Mechanics Co., Ltd	GNA Series	125 V~, FLA: 20 A, LRA: 80 A, operating temperature -21.5 °C ~ 17.0 °C	cURus
9	30	Junction Box (all models)	POSCO	Stamped sheet steel	Min. thickness 0.7 mm, overall dimensions 50 x 150 x 232 mm, secured to body frame by screws	NR
			B&G Steel			
9	31	Internal wire for Temperature Controller	Various	1015	600 V~, 16 AWG, 105 °C, VW-1	UL
9	32	Insulation Tube	DAEIL C S T CO	DDITC Series	600 V~, 105 °C, V-0	URus, CSA
9	33	Internal wire for SMPS	Various	1015	600 V~, 16 AWG, 105 °C, VW-1	UL

4.0 Critical Components						
Photo #	Item no. ¹	Name	Manufacturer/ trademark ²	Type / model ²	Technical data and securement means	Mark(s) of conformity ³
9	34	SMPS (TIDC-26W, TIDC-47W, TIDC-70W)	MEAN WELL ENTERPRISES CO LTD	LPV-20-24	Input: (100-240) V~, 0.55 A, output: 24 Vdc, 0.84 A	cURus
		SMPS (TIDC-91W)		LPV-35-24	Input: (100-240) V~, 1.1 A, output: 24 Vdc, 1.5 A	
9	35	Bushing	KAI SUH SUH Enterprise Co.,Ltd	EG11L	V-2, mounting hole 18.3 mm, outer diameter 13.2 mm, mounted to side enclosure by snap-in	URus
9	36	Knob of Temperature controller (all models)	Cheil Industries	QU-0191(+)	HB, RTI(60, 60, 60), min. thickness 0.75 mm, secured to temperature controller by snap-in	cURus
9	37	Drier (all models)	DANFOSS	DML 032S	Min. wall thickness 1.0 mm, outer diameter 46.5 mm, total length 98 mm, located between condenser and capillary tubing by welding	NR
9	38	Compressor (TIDC-26W)	Samsung Electronics Co.,Ltd	SK1A1C-L2W	115 V~, 60 Hz, RLA 3.5, LRA 24.6, R-134a, marked with "Thermally protected", approved starting capacitor 125 V~, 125 µF and running capacitor 250 V~, 12 µF, secured to machinery compartment base by bolt and nut	cURus
9	39	Lead wire for compressor	Various	1015	600 V~, 16 AWG, 105 °C, VW-1	UL
9	40	Motor Connector	Molex Incorporated	35150 35151	300 V~, 15 A	URus, CSA
9	41	Compressor Connector	Molex Incorporated	35150 35151	300 V~, 15 A	URus, CSA
9	42	Condenser fan motor (all models)	Sung Shin Motor Technology Co., Ltd	IS-4420DWSG-1	115 V~, 60 Hz, 0.68 A, refer to UL report SA11863SP, Vol. 2, Sec 1	See 5.0
9	43	Condenser (TIDC-26G)	Various	Steel tubing with black coating	Min. thickness 0.7 mm, outer diameter 4.76 mm, overall dimension is 240 x 180 x 100 mm, total length 14.8 m, secured to machinery compartment base by screw, refer to Illustration No. 19 for details	NR
9	44	Insulation for capacitor	Various	Various	Min. thickness 8 mm, dimension is 50 x 120 mm	NR
10	45	Compressor (TIDC-47W)	Tecumseh Products Co	CAE2420Z	(110-115) V~, 50/60 Hz, RLA 6.7/6.6, LRA 11.3/11.1, R-404A, marked with "Thermally protected", approved starting capacitor 160 V~, 315 µF, secured to machinery compartment base by bolt and nut	cURus

4.0 Critical Components						
Photo #	Item no. ¹	Name	Manufacturer/ trademark ²	Type / model ²	Technical data and securement means	Mark(s) of conformity ³
10	46	Capillary Tube (all models)	Various	Copper	Min. wall thickness 0.7 mm, outer diameter 2.3 mm, total Length 2.80 m	NR
10	47	Tubing for lead wire (all models)	DAE MYUNG ELECTRIC	VIT-300	300 V~, 105 °C, VW-1	cURus
10	48	Condenser (TIDC-47W)	Various	Steel tubing with black coating	Min. thickness 0.7 mm, outer diameter 4.76 mm, overall dimension is 240 x 230 x 100 mm, total length 8.4 m, Secured to machinery compartment base by screw	NR
10	49	Internal wire for grounding	Various	1015	600 V~, 16 AWG, 105 °C, VW-1	UL
11	50	Magnetic contactor (TIDC-70W, TIDC-91W)	LS Industrial Systems	GMC-30P2	220 V~, 30 A, interrupting capacity: 180 A	cURus
11	51	Timer (TIDC-70W, TIDC-91W)	KUN HUNG Electric Co.,Ltd	KTM-1S	(90-240) V~, 60 Hz, 3 A	cURus
11	52	Insulation Tube for Timer terminal	DONG A BESTECH CO LTD	ATSSP series	18 AWG, insulation material: PVC or nylon	URus
11	53	Cover with timer and Magnetic contactor	POSCO B&G Steel	Stamped sheet steel	Min. thickness 0.6 mm, dimension is 142 x 119 x 105 mm, secured to body frame by screw	NR
11	54	Compressor, 2 employed (TIDC-70W)	Samsung Electronics Co.,Ltd	SK1A1C-L2W	115 V~, 60 Hz, RLA 3.5, LRA 24.6, R-134a, marked with "Thermally protected", approved starting capacitor 125 V~, 125 µF and running capacitor 250 V~, 12 µF, secured to machinery compartment base by bolt and nut	cURus
11	55	Condenser, 2 employed (TIDC-70W)	Various	Steel tubing	Min. thickness 0.7 mm, outer diameter 4.76 mm, overall dimension is 240 x 180 x 100 mm, total length 14.8 m, secured to machinery compartment base by screw, refer to Illustration No. 19 for details	NR
12	56	Thermal insulation	Various	Various	Min. thickness 8 mm	NR
12	57	Compressor (TIDC-91W)	Samsung Electronics Co.,Ltd	SK1A1C-L2W	115 V~, 60 Hz, RLA 3.5, LRA 24.6, R-134a, marked with "Thermally protected", approved starting capacitor 125 V~, 125 µF and running capacitor 250 V~, 12 µF, secured to machinery compartment base by bolt and nut	cURus

4.0 Critical Components						
Photo #	Item no. ¹	Name	Manufacturer/ trademark ²	Type / model ²	Technical data and securement means	Mark(s) of conformity ³
12	58	Condenser (TIDC-91W)	Korea Bundy Corp	Steel tubing	Min. thickness 0.7 mm, outer diameter 4.76 mm, overall dimensions 240 × 230 × 100 mm, total length 8.4 m, secured to compressor base by screw, Refer to Illustration No. 19 for details	NR
12	59	Compressor (TIDC-91W)	Tecumseh Products Co	CAE2420Z	(110-115) V~, 50/60 Hz, RLA 6.7/6.6, LRA 11.3/11.1, R-404A, marked with "Thermally protected", approved starting capacitor 160 V~, 315 µF, secured to machinery compartment base by screw	cURus
12	60	Condenser (TIDC-91W)	Various	Steel tubing	Min. thickness 0.7 mm, outer diameter 4.76 mm, overall dimensions 240 × 230 × 100 mm, total length 10.3 m, secured to compressor base by screw, refer to Illustration No. 18 for details	NR
13	61	LED Cover (TIDC-26W)	LG Chemical Ltd	LI943	HB, HWI(3), HAI(0), RTI(50, 50, 50), min. thickness 1.5 mm, overall dimension is 16.5 × 14 × 468 mm, secured to aluminum frame by snap-in	cURus
		LED Cover (TIDC-47W)			HB, HWI(3), HAI(0), RTI(50, 50, 50), min. thickness 1.5 mm, overall dimension is 16.5 × 14 × 910 mm, secured to aluminum frame by slide	
		LED Cover (TIDC-70W)			HB, HWI(3), HAI(0), RTI(50, 50, 50), min. thickness 1.5 mm, overall dimension is 16.5 × 14 × 1197 mm, secured to aluminum frame by slide	
		LED Cover, 2 units employed (TIDC-91W)			HB, HWI(3), HAI(0), RTI(50, 50, 50), min. thickness 1.5 mm, overall dimension is 16.5 × 14 × 910 mm, 32.8 × 15 × 910 mm, secured to aluminum frame by slide	
13	62	LED light	Alti-semiconductor Co.,Ltd	AT558TWBZ3	324 mW, 30 mA, PWB: overall dimension is 13 x 755 mm, min. thickness 2 mm	NR
13	63	Cover for LED lead wire	POSCO B&G Steel	Stamped sheet steel	min. thickness 0.7 mm, dimension is 90 × 117 mm, secured to body frame by screw	NR
13	64	Close end connector	TYCO ELECTRONICS	0440386 series	600 V~, 105 °C	cURus

4.0 Critical Components

Photo #	Item no. ¹	Name	Manufacturer/ trademark ²	Type / model ²	Technical data and securement means	Mark(s) of conformity ³
13	65	Holder for LED	LG Chemical Ltd	AF302	250 V~, 1A, 5VB, HWI(3), HAI(0), RTI(60, 60, 60), CTI(2), min. thickness 2.5 mm, secured to aluminum frame by screw	cURus
13	66	Lead wire for LED	Various	1007	300 V~, 20 AWG, 80 °C, VW-1	UL
14	67	Evaporator (TIDC-26W)	Shin Kwang Engineering Co., Ltd	Aluminum tubing	Min. thickness 0.8 mm, outer diameter 8.5 mm, 8 turns, total length 18.2 m, secured to outside of inner enclosure by aluminum tape, refer to Illustration No. 20 for details	NR
		Evaporator (TIDC-47W)			Min. thickness 0.8 mm, outer diameter 8.5 mm, 8 turns, total length 26.8 m, secured to outside of inner enclosure by aluminum tape, refer to Illustration No. 20 for details	
		Evaporator 2 units employed (TIDC-70W)			Min. thickness 0.8 mm, outer diameter 8.5 mm, 4 turns, total length 36.3 m, secured to outside of inner enclosure by aluminum tape, connected to each refrigerant system, refer to Illustration No. 21 for details	
		Evaporator 2 units employed (TIDC-91W)			Min. thickness 0.35 mm, outer diameter 8.5 mm, 4 turns, total length 44.8 m, secured to outside of inner enclosure by aluminum tape, connected to each refrigerant system, refer to Illustration No. 21 for details	

NOTES:

1) Not all item numbers are indicated (called out) in the photos, as their location is obvious.

2) "Various" means any type, from any manufacturer that complies with the "Technical data and securement means" and meets the "Mark(s) of conformity" can be used.

3) Indicates specific marks to be verified, which assures the agreed level of surveillance for the component. "NR" - indicates Unlisted and only visual examination is necessary. "See 5.0" indicates Unlisted components or assemblies to be evaluated periodically refer to section 5.0 for details.

11. How do I exchange a part of each major cuts

1. DETACHMENT OF ASS'Y DOOR



1. DETACH ASS'Y DOOR BY PULLING UP THE LOCK LIKE THE PICTURE.
2. FOLLOW THE REVERSE WAY OF DETACHMENT FOR THE ATTACHMENT AFTER FINISHING THE SERVICE.

2. DETACHMENT OF DOOR HINGE



1. HOLD RUBBER PACKING IN THE BLACK CIRCLE BY (-) DRIVER AND DETACH HEXAGON HEAD BOLT BY SPANNER OR PLIER.
2. FOLLOW THE REVERSE WAY OF DETACHING FOR THE ATTACHMENT AFTER FINISHING THE SERVICE.

3. REPLACEMENT OF DOOR AND HANDLE DOOR

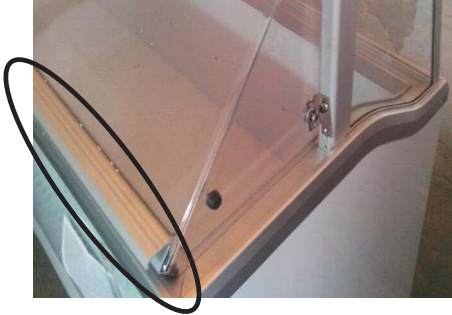

1. DOOR AND HANDLE DOOR CAN NOT BE REPLACED AS IT IS ATTACHED BY SILICON GLUE.
2. IN ORDER TO REPLACE DOOR AND HANDLE DOOR, PLEASE ORDER ASS'Y DOOR OR ASS'Y HANDLE DOOR OR PLEASE ASSEMBLE EACH PARTS BY SILICON GLUE.

4. REPAIR OF IMPROPER BALANCE OF ASS'Y DOOR



1. REMOVE DUST ON THE SIDE OF ASS'Y DOOR AND SPRAY THE GREASE ON THE JOINT OF ASS'Y DOOR IN ORDER TO EASE THE FRICTION.

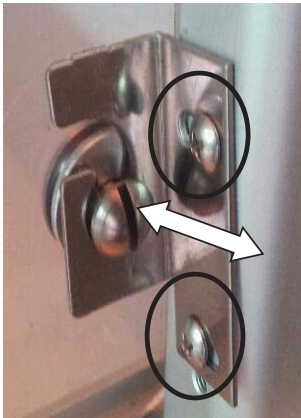

2. IF IT CAN NOT BE FIXED BY SOLUTION NO. 1, RELEASE SCREWS LITTLE BY (+) DRIVER AND SET BALANCE OF HINGE BY ADJUSTING RIGHT AND LEFT AND THEN ASSEMBLE ASS'Y DOOR AGAIN.
3. IF IT CAN NOT BE FIXED BY SOLUTION 1 AND 2, PLEASE REPLACE ASS'Y DOOR IN ORDER TO FIX.

5. REPLACEMENT OF LED SWITCH AND LED LIGHT



1. RELEASE SCREWS IN THE BLACK CIRCLES BY (+) DRIVER.



2. REPLACE SWITCH AFTER DETACHMENT OF HARNESS OF SWITCH.



3. RELEASE SCREWS IN THE BLACK CIRCLE BY (+) DRIVER.



4. CUT THE LED WIRE.
(THE THINEST WIRES IN RED(+), BLUE(-) ARE LED WIRE)



5. PICK OUT ASS'Y LED FROM SNAP PART AND REPLACE THE LED.
PUSH WIRES IN SNAP PART WHEN YOU REATTACH ASS'Y LED.

6. YOU SHOULD CONNECT WIRES OF DC 24V IN SAME COLOR.(RED(+) TO RED(+), BLUE(-) TO BLUE(-))
OR IT WOULD BE CAUSE OF FIRE ACCIDENT.

6. REPLACEMENT OF WINDOW, WINDOW L,R, POLE SUPPORT



1. RELEASE SCREWS IN THE BLACK CIRCLE BY (+) DRIVER.



2. DETACH A HARNESS OF SWITCH.

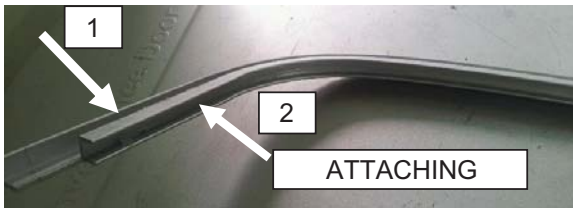

FRAME WINDW

3. FRAME WINDOW CONSISTS OF WINDOW WITH [1], [2] AND [5] ATTACHED BY SILICON. IN ORDER TO DETACH, PULL WINDOW TOWARD [3] THEN WINDOW WILL BE APART FROM SIDE WINDOW.

4. DETACH FRAME WINDOW FROM WINDOW BY PULLING APART TOWARD [4] AND [3].

5. IN ORDER TO ASSEMBLE FRAME WINDOW, ATTACH FRAME WINDOW TO WINDOW AFTER SPREADING LITTLE SILICON GLUE ON [1] AND [2]. (IF FRAME WINDOW CAN BE ATTACHED TO WINDOW DUE TO HARDENED SILICON GLUE, YOU SHOULD ORDER NOT ONLY FRAME WINDOW BUT ALSO WINDOW.)

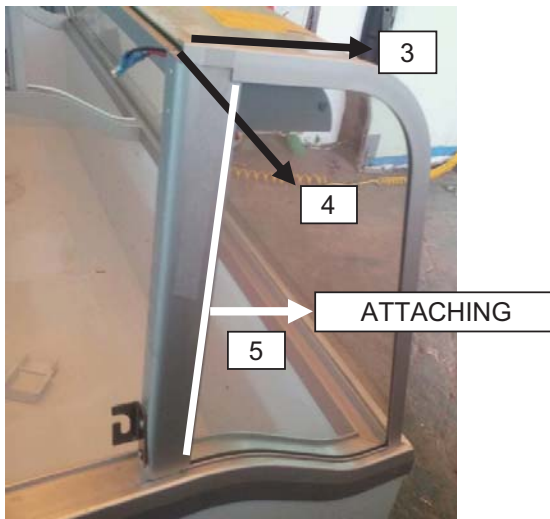

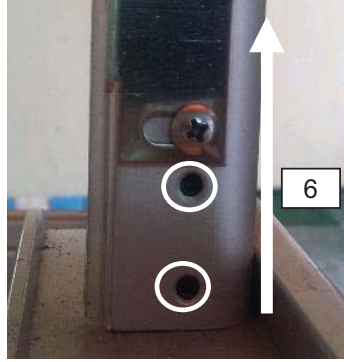

POLE SUPPORT

7. INORDER TO DETACH WINDOW L/R FROM POLE SUPPORT, RELEASE WRENCH BOLTS IN THE HOLE BY 2.5mm WRENCH AND THEN PULL THE POLE UP TO [6] IN THE VERTICAL WAY. (OR FRAME WILL BE BROKE.)
8. IF WINDOW L/R CAN NOT BE DETACHED FROM POLE SUPPORT, YOU SHOULD ORDER BOTH OF WINDOW L/R AND POLE SUPPORT FOR REPLACEMENT.
9. PLEASE FOLLOW REVERSE WAY TO ATTACH THE WINDOW.

7. REPLACEMENT OF PARTS IN THE MACHINARY ROOM

ASS'Y GRILL

BRACKET
COMP BASE

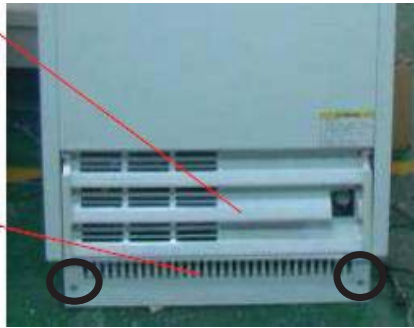

1. RELEASE SCREWS ON BOTH SIDE OF BOTTOM BY (+) DRIVER AND THEN DETACH BRACKET COMP BASE.

1



2



2. DETACH ASS'Y GRILL BY FOLLOWING THE STEP AS BELOW;

1. PULL THE GRILL UP LIKE [1]
2. PULL THE JOINT OF GRILL TOWARD [2]

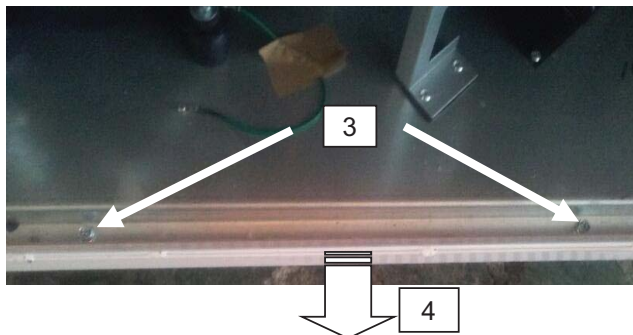

3. RELEASE TWO BOLTS ON [3] BY (+) DRIVER AND PULL THE POLE TOWARD [4].

12. How to bridge major parts exchange

Photo 11 - Machinery compartment view of model TIDC-70W

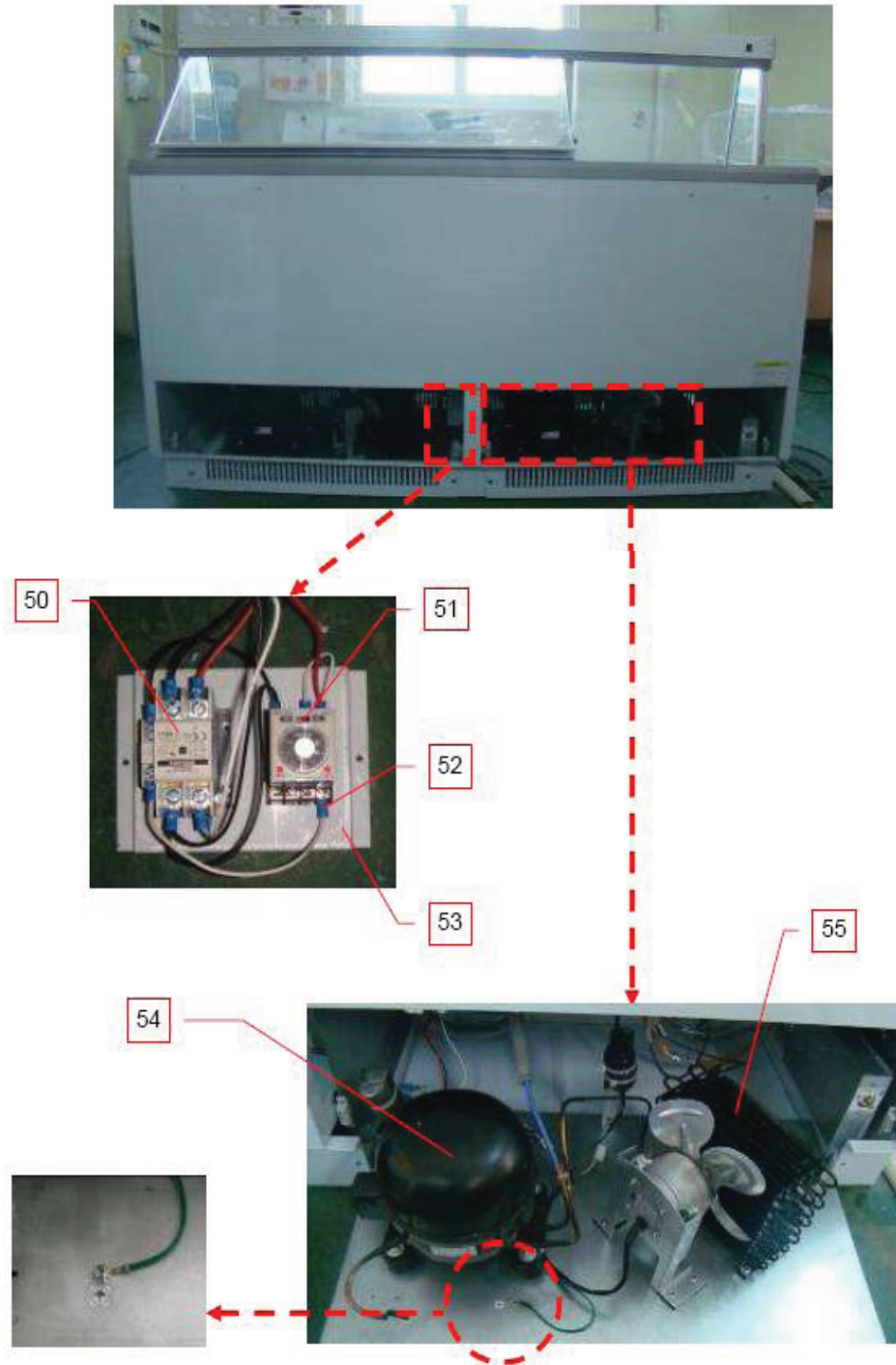

REFER TO PRODUCT PHOTOGRAPHS ON 13 PAGE IN ORDER TO REPLACE ELECTRICAL PARTS IN MACHINERY ROOM.

13. Compressor Specifications

Series : SK [REV NO.:0 NOV.2003]		MODEL : SK1A1C-L2W
C O M P R E S S O R		
SAMSUNG ELECTRONICS CO.,LTD.		115V-60Hz
APPLICATION		CSR
Evaporating temp.range		- 35 ~ -15 °C
Refrigerant		R 134a
Refrigerant control		Capillary tube
Compressor cooling		Fan
PERFORMANCE		115V-60Hz
Cooling capacity	Kcal/hr	303
Power input	Watt	275
Efficiency	Kcal/Whr	1.10
Current	Amp	3.5
Testing conditions		
Evaporating temp.	°C	-23.3
Condensing temp.	°C	54.4
Ambient temp.	°C	32.2
Liquid subcooled to	°C	32.2
Gas superheated to	°C	32.2
COMPRESSOR DATA		
Design		Reciprocating Con-Rod
Displacement	cc/Rev	10.68
Speed	RPM	3500
Oil	cc	235
Compressor weight(with Oil)	Kg	10.8
Tube connection		
Process & Suction tube	mm	O.D 7.94 / I.D 6.54
Discharge tube	mm	O.D 6.35 / I.D 4.95
Oil-cooler tube	mm	-
MOTOR DATA		
Motor type		PTC-CSR
Norminal voltage range	Voltage	98-127V
High potential test	V/sec	1500
Rated current	Amp	3.5
Locked rotor current	Amp	24.6
Starting capacitor	VAC-µF	125 - 125
Running capacitor	VAC-µF	250 - 12
OVERLOAD PROTECTOR		4TM795TFBZZ-53
Cut-out temp.	°C	140 ± 5
Cut-in temp.	°C	61 ± 9
UTC	Amp	7.49
Time current performance		
TIME CHECK CURRENT	Amp/sec	23.0 / 10 ± 5
STARTING RELAY		22Ω - 3PIN
Resistance	Ω	22
Max voltage	Voltage	350

Compresseur / Compressor
Code tension / Voltage code : A

CAE2420Z

Froid commercial négatif (BP)
Low back pressure commercial application

100-115V / 50-60Hz - 1~

R404A

N° 123JS-A - ind b

Conditions Conditions	fréquence frequency	Prod frigorifique nominale / nominal refrigerating capacity			Puis. sonore Sound level
		Watts	Kcal/h	BTU/h	
Standard	50 Hz	547	470	1865	54 dBA
Standard	60 Hz	665	572	2268	
Cecomaf	50 Hz	361			
Cecomaf	60 Hz	441			

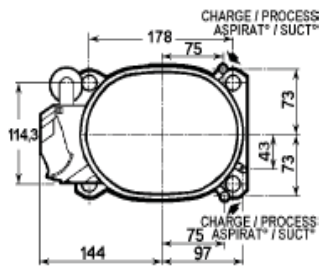
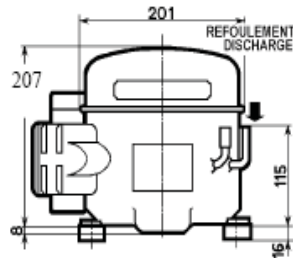

Cylindrée / Displacement : 12,54 cm³
Poids net / Net weight : 12,5 Kg
Charge en huile / Oil charge : 450 cm³
Type d'huile / Oil type : P.O.E /
Détente / Expansion device : Capillaire/Détendeur
Capillary/Exp* valve
Refroidissement / Cooling : Ventilé / Forced

Résistance à 20° C / Windings resistances at 20° C
Phase princ. / Main Winding : 0,85 Ohms
aux. / Auxiliary Winding : 3,09 Ohms

Intensité / Current
nom. / Rated current RLA : 6,7 / 6,6 A
max. / Max current : 11,3 / 11,1 A
dém. / Start current LRA : 35 / 40 A

Ap. Electrique / Electrical equipment : CSIR

Protecteur / Overload : MST16AHN
Temporisation / Time Check : 2,8s - 5,2s / 30 A
T° ouverture / Opening temp. : 120° C
fermeture / Closing temp. : 69° C
Option / optional : T0593

Relais Intensité / Current relay : 3ARR12KP*483
enclenchement / Pick up : 19,6A
déclenchement / Drop out : 16,4A
Option / optional : /

Condensateur dém. / Start capacitor : 315 µF / 160 V

Pour conduites Ø ext / For tubing O.D.

Aspiration Suction	Refolement Discharge	Charge Process
9,5 (3/8")	6,35 (1/4")	9,5 (3/8")



14-1. TIDC-26 Decomposition Assembly Drawing

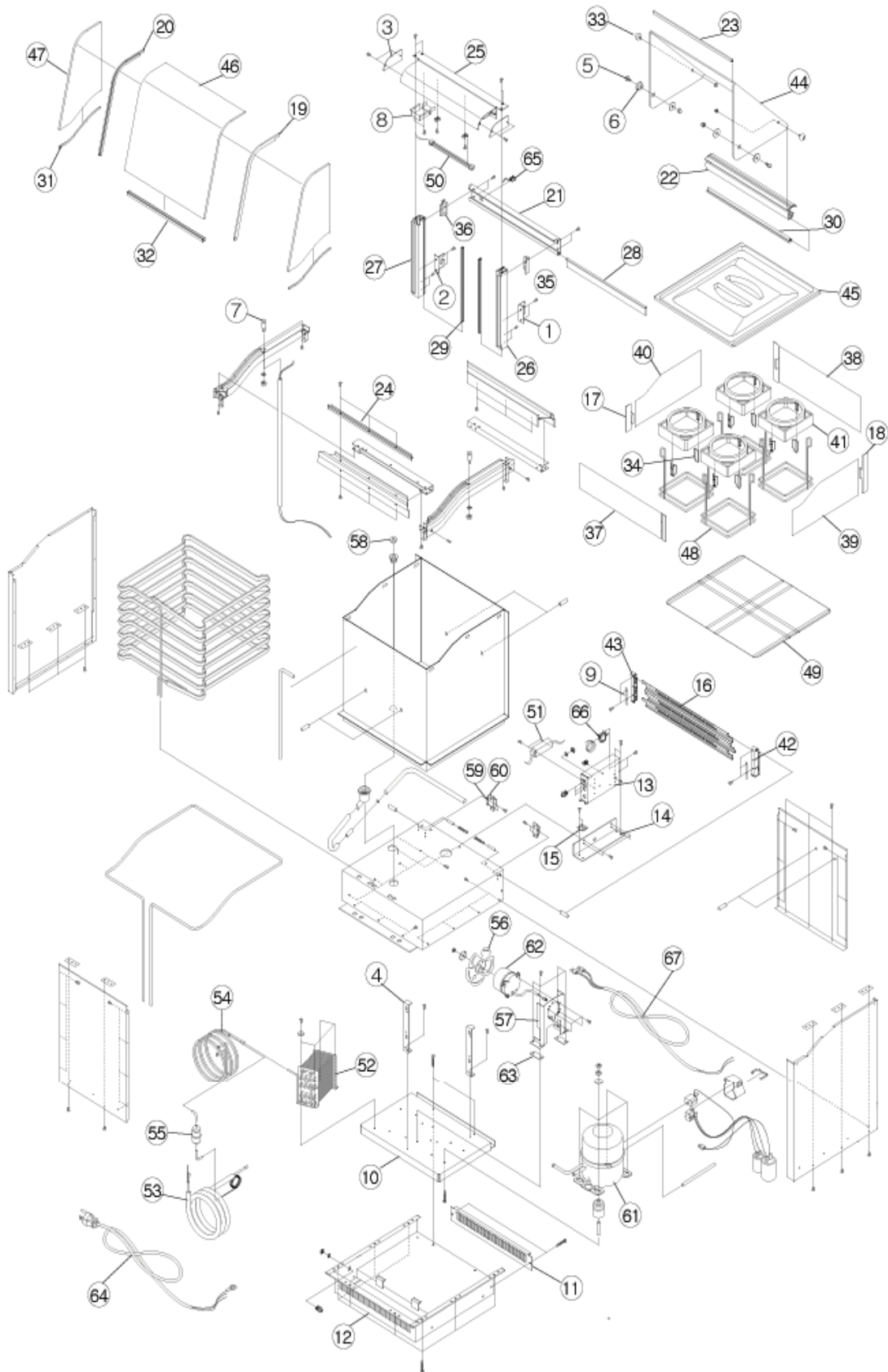

14-2. TIDC-26 Decomposition Assembly Drawing Component

NO	PART CODE	PART NAME	DESCRIPTION	Q'TY
				26W
1	P0106S0100	BRACKET HINGE*L	SUS-304 t1.5	1
2	P0106S0200	BRACKET HINGE*R	SUS-304 t1.5	1
3	P0114S0100	COVER LAMP*L*R	EGI t0.8	2
4	P0106S0400	BRACKET BODY		2
5	P0129S0100	HINGE DOOR*L*R	MSWR	2
6	P0129S0200	HINGE DOOR	AL	2
7	P0149S0100	INSERT POLE	MSWR	2
8	P0114S1900	COVER LAMP WIRE	EGI t0.6	1
9	P0145S0100	PLATE MAGNET GRILL	SPG t0.6	2
10	P0103S0100	BASE COMP	SPG t1.6	1
11	P0106S0900	BRACKET COMP BASE	SPG t2.0	1
12	P0100S0100	ASSY FRAME MECH		1
13	P0111S0100	CASE PCB	SPG t0.8	1
14	P0106S1300	BRACKET PCB ASSY	SPG t1.6	1
15	P0106S1400	BRACKET PCB CASE	SPG t1.0	1
16	P0124S0100	GRILL PLATE A (4CAN)	EGI t0.6	3
17	P0175S0100	HANDLE PAD MAGNET	SUS304 t0.8*154	2
18	P0175S0200	HANDLE PAD MAGNET	SUS304 t0.8*230	2
19	P0122S2200	FRAME WINDOW*L	AL	1
20	P0122S2300	FRAME WINDOW*R	AL	1
21	P0122S2400	FRAME WINDOW*B	AL 63.5*619	1
22	P0126S0100	HANDLE DOOR	AL W*548	1
23	P0122S2800	FRAME DOOR	AL W*548	1
24	P0122S3000	FRAME BODY*B	AL W*626	1
25	P0111S0200	CASE LAMP	AL W*622.6	1
26	P0153S0100	POLE SUPPORT*L	AL W*382.5	1
27	P0153S0100	POLE SUPPORT*R	AL W*382.5	1
28	P0123S0100	GASKET DOOR	PVC W*616	1
29	P0123S0500	GASKET DOOR*S*L*R	PVC W*382	2
30	P0123S0600	GASKET HANDLE	PVC W*552	1
31	P0123S0800	GASKET WINDOW*S*L*R	PVC W*280	2
32	P0123S1100	GASKET WINDOW*U	PVC W*602	1
33	P0152S0100	STOPPER DOOR*L*R	RUBBER	2
34	P0107S0200	BUSHING CAN COVER	RUBBER	8
35	P0114S2000	COVER FRAME WIN*L	RUBBER	1
36	P0114S2100	COVER FRAME WIN*R	RUBBER	1
37	P0141S1100	PAD MAGNET*F	M.P 154*530	1
38	P0141S1700	PAD MAGNET*B	M.P 230*530	1
39	P0141S1500	PAD MAGNET*L	M.P 230*526.5	1
40	P0141S1600	PAD MAGNET*R	M.P 230*526.5	1
41	P0114S2200	CAN COVER	ABS	4
42	P0130S0100	HOLDER GRILL PLT*L	NYLON 6	1
43	P0130S0200	HOLDER GRILL PLT*R	NYLON 6	1
44	P0117S0100	DOOR	PC t4.5	1
45	P0114S2300	COOLING COVER	ABS t2.0	1
46	P0155S0100	WINDOW	GLASE t6.0	1
47	P0155S0500	WINDOW*S*L*R	GLASE t6.0	2
48	P0178S0100	WIRE RACK*A	WIRE	4
49	P0178S0200	FRAME-RACK	"	1
50	P0138S0100	ASSY LED LAMP	LED BAR 468	1
51	P0185S0100	POWER SUPPLY (SMPS)	LPV-20-24	1
52	P0100S0500	CONDENSER	4 LINE 8 COLUMN	1
53	P0144S1200	PIPE SUCTION (26W)		1
54	P0100S0700	SUB-CONDENSER	ø4.76*ø200	1
55	P0168S0100	DRYER	DML 032S	1
56	30218B0300	FAN RADI	ø200 (SUCTION)	1
57	3.021E+09	BRACKET SUBORT (A)		1
58	PO109S0100	CAP DRAIN	PA-6	1
59	30275U0200	MAG STOPPER GRILL PLT		2
60	30206A4600	BRACKET MAGNET		2
61	30200Q1200	SAMSUNG COMPRESSOR	SK1A1C-L2W 115V	1
62	3.963E+09	MOTOR SHADED POLE	IS-4420DWSG-1	1
63	4VMOA15630	CUSH FAN-MOTOR FIXR		2
64	30213A1014	POWER CORD		1
65	30281Q0101	S/W LAMP		1
66	30283N0100	THERMOSTAT	GNF-107DC	1
67	P0127S0200	COMP WIRE	4P (SAMSUNG COMP)	1

15-1. TIDC-47 Decomposition Assembly Drawing

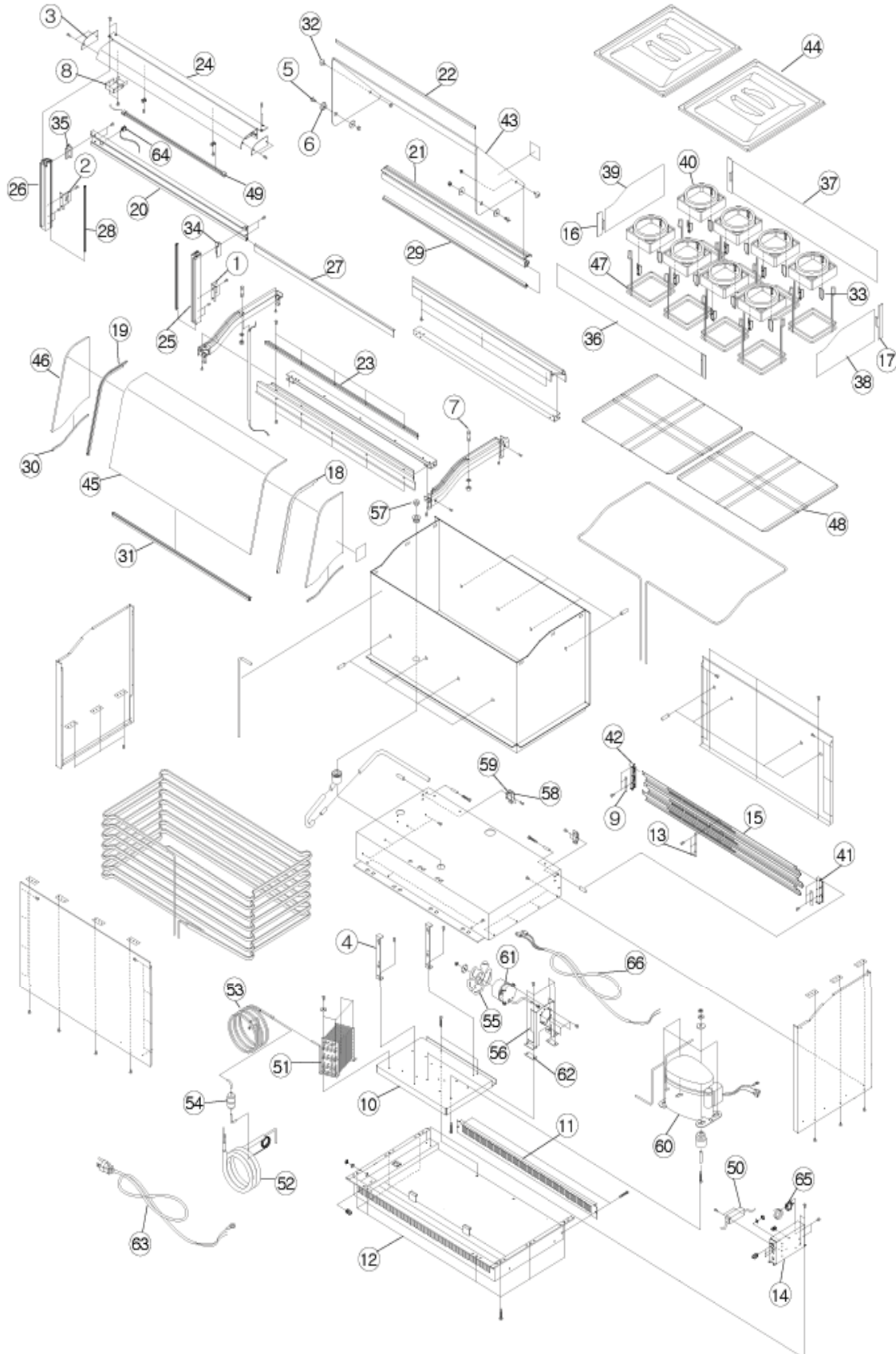

15-2. TIDC-47 Decomposition Assembly Drawing Component

NO	PART CODE	PART NAME	DESCRIPTION	Q'TY
				47W
1	P0106S0100	BRACKET HINGE*L	SUS-304 t1.5	1
2	P0106S0200	BRACKET HINGE*R	SUS-304 t1.5	1
3	P0114S0100	COVER LAMP*L*R	EGI t0.8	2
4	P0106S0400	BRACKET BODY		2
5	P0129S0100	HINGE DOOR*L*R	MSWR	2
6	P0129S0200	HINGE DOOR	AL	2
7	P0149S0100	INSERT POLE	MSWR	2
8	P0114S1900	COVER LAMP WIRE	EGI t0.6	1
9	P0145S0100	PLATE MAGNET GRILL	SPG t0.6	2
10	P0103S0200	BASE COMP	SPG t1.6	1
11	P0106S1000	BRACKET COMP BASE	SPG t2.0	1
12	P0100S0200	ASSY FRAME MECH		1
13	P0106S0700	BRACKET GRILL	SPG t1.0	1
14	P0111S0100	CASE PCB	SPG t0.8	1
15	P0124S0200	GRILL PLATE A (8CAN)	EGI t0.6	3
16	P0175S0100	HANDLE PAD MAGNET	SUS304 t0.8*154	2
17	P0175S0200	HANDLE PAD MAGNET	SUS304 t0.8*230	2
18	P0122S2200	FRAME WINDOW*L	AL	1
19	P0122S2300	FRAME WINDOW*R	AL	1
20	P0122S2500	FRAME WINDOW*B	AL 63.5*1151	1
21	P0126S0200	HANDLE DOOR	AL W*1080	1
22	P0122S2900	FRAME DOOR	AL W*1080	1
23	P0122S3100	FRAME BODY*B	AL W*1158	1
24	P0111S0300	CASE LAMP	AL W*1154.6	1
25	P0153S0100	POLE SUPPORT*L	AL W*382.5	1
26	P0153S0100	POLE SUPPORT*R	AL W*382.5	1
27	P0123S0200	GASKET DOOR	PVC W*1150	1
28	P0123S0500	GASKET DOOR*S*L*R	PVC W*382	2
29	P0123S0700	GASKET HANDLE	PVC W*1084	1
30	P0123S0900	GASKET WINDOW*S*L*R	PVC W*280	2
31	P0123S1200	GASKET WINDOW*U	PVC W*1134	1
32	P0152S0100	STOPPER DOOR*L*R	RUBBER	2
33	P0107S0200	BUSHING CAN COVER	RUBBER	16
34	P0114S2000	COVER FRAME WIN*L	RUBBER	1
35	P0114S2100	COVER FRAME WIN*R	RUBBER	1
36	P0141S1200	PAD MAGNET*F	M.P 154*1060	1
37	P0141S1800	PAD MAGNET*B	M.P 230*1060	1
38	P0141S1500	PAD MAGNET*L	M.P 230*526.5	1
39	P0141S1600	PAD MAGNET*R	M.P 230*526.5	1
40	P0114S2200	CAN COVER	ABS	8
41	P0130S0100	HOLDER GRILL PLT*L	NYLON 6	1
42	P0130S0200	HOLDER GRILL PLT*R	NYLON 6	1
43	P0117S0200	DOOR	PC t4.5	1
44	P0114S2300	COOLING COVER	ABS t2.0	2
45	P0155S0200	WINDOW	GLASE t6.0	1
46	P0155S0500	WINDOW*S*L*R	GLASE t6.0	2
47	P0178S0100	WIRE RACK*A	WIRE	8
48	P0178S0200	FRAME-RACK	"	2
49	P0138S0200	ASSY LED LAMP	LED BAR 910	1
50	P0185S0100	POWER SUPPLY (SMPS)	LPV-20-24	1
51	P0100S0600	CONDENSER	4 LINE 10COLUMN	1
52	P0144S1300	PIPE SUCTION (47,70,91W)		1
53	P0100S0700	SUB-CONDENSER	ø4.76*ø200	1
54	P0168S0100	DRYER	DML 032S	1
55	30218B0300	FAN RADI	ø200 (SUCTION)	1
56	3.021E+09	BRACKET SUBORT (A)		1
57	PO109S0100	CAP DRAIN	PA-6	1
58	30275U0200	MAG STOPPER GRILL PLT		2
59	30206A4600	BRACKET MAGNET		2
60	30200R1100	FRANCE COMPRESSOR	CAE2420Z 115V	1
61	3.963E+09	MOTOR SHADED POLE	IS-4420DWSG-1	1
62	4VMOA15630	CUSH FAN-MOTOR FIXR		2
63	30213A1014	POWER CORD		1
64	30281Q0101	S/W LAMP		1
65	30283N0100	THERMOSTAT	GNF-107DC	1
66	P0127S0100	COMP WIRE	2P (FRANCE COMP)	1

16-1. TIDC-70 Decomposition Assembly Drawing

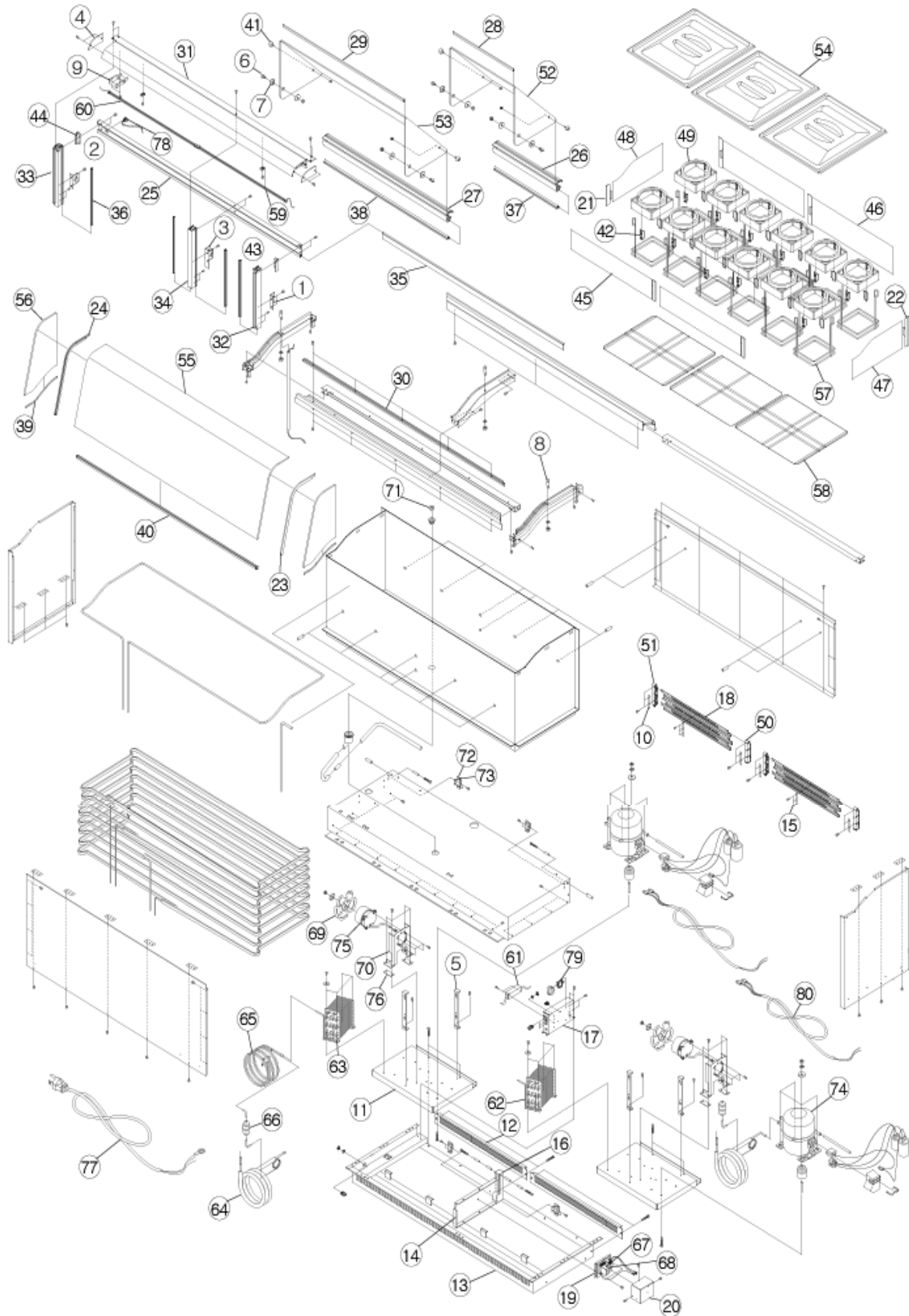

16-2. TIDC-70 Decomposition Assembly Drawing Component

NO	PART CODE	PART NAME	DESCRIPTION	Q'TY 70W
1	P0106S0100	BRACKET HINGE*L	SUS-304 t1.5	1
2	P0106S0200	BRACKET HINGE*R	SUS-304 t1.5	1
3	P0106S0300	BRACKET HINGE*M	SUS-304 t1.5	1
4	P0114S0100	COVER LAMP*L*R	EGI t0.8	2
5	P0106S0400	BRACKET BODY		4
6	P0129S0100	HINGE DOOR*L*R	MSWR	2
7	P0129S0200	HINGE DOOR	AL	2
8	P0149S0100	INSERT POLE	MSWR	3
9	P0114S1900	COVER LAMP WIRE	EGI t0.6	1
10	P0145S0100	PLATE MAGNET GRILL	SPG t0.6	4
11	P0103S0200	BASE COMP	SPG t1.6	2
12	P0106S1000	BRACKET COMP BASE	SPG t2.0	2
13	P0100S0300	ASSY FRAME MECH		1
14	P0106S1200	BRK FRAME MECA	SPG t2.0	1
15	P0106S0700	BRACKET GRILL	SPG t1.0	2
16	P0106S0800	BRACKET GRILL*M	EGI t1.0	1
17	P0106S1300	CASE PCB	SPG t0.8	1
18	P0124S0300	GRILL PLATE A (12CAN)	EGI t0.6	6
19	P0106S1900	BRACKET TIMER	SPG t1.0	1
20	P0114S2000	COVER TIMER	SPG t0.6	1
21	P0175S0100	HANDLE PAD MAGNET	SUS304 t0.8*154	3
22	P0175S0200	HANDLE PAD MAGNET	SUS304 t0.8*230	3
23	P0122S2200	FRAME WINDOW*L	AL	1
24	P0122S2300	FRAME WINDOW*R	AL	1
25	P0122S2600	FRAME WINDOW*B	AL 63.5*1747	1
26	P0126S0100	HANDLE DOOR	AL W*548	1
27	P0126S0200	HANDLE DOOR	AL W*1080	1
28	P0122S2800	FRAME DOOR	AL W*548	1
29	P0122S2900	FRAME DOOR	AL W*1080	1
30	P0122S3200	FRAME BODY*B	AL W*1753	1
31	P0111S0400	CASE LAMP	AL W*1750.6	1
32	P0153S0100	POLE SUPPORT*L	AL W*382.5	1
33	P0153S0100	POLE SUPPORT*R	AL W*382.5	1
34	P0153S0200	POLE SUPPORT*M	AL W*382.5	1
35	P0123S0300	GASKET DOOR	PVC W*1746	1
36	P0123S0500	GASKET DOOR*S*L*R	PVC W*382	4
37	P0123S0600	GASKET HANDLE	PVC W*552	1
38	P0123S0700	GASKET HANDLE	PVC W*1084	1
39	P0123S0900	GASKET WINDOW*S*L*R	PVC W*280	2
40	P0123S1300	GASKET WINDOW*U	PVC W*1730	1
41	P0152S0100	STOPPER DOOR*L*R	RUBBER	4
42	P0107S0200	BUSHING CAN COVER	RUBBER	24
43	P0114S2000	COVER FRAME WIN*L	RUBBER	1
44	P0114S2100	COVER FRAME WIN*R	RUBBER	1
45	P0141S1300	PAD MAGNET*F	M.P 154*825	2
46	P0141S1900	PAD MAGNET*B	M.P 230*825	2
47	P0141S1500	PAD MAGNET*L	M.P 230*526.5	1
48	P0141S1600	PAD MAGNET*R	M.P 230*526.5	1
49	P0114S2200	CAN COVER	ABS	12
50	P0130S0100	HOLDER GRILL PLT*L	NYLON 6	2
51	P0130S0200	HOLDER GRILL PLT*R	NYLON 6	2
52	P0117S0100	DOOR	PC t4.5	1
53	P0117S0200	DOOR	PC t4.5	1
54	P0114S2300	COOLING COVER	ABS t2.0	3
55	P0155S0300	WINDOW	GLASE t6.0	1
56	P0155S0500	WINDOW*S*L*R	GLASE t6.0	2
57	P0178S0100	WIRE RACK*A	WIRE	12
58	P0178S0200	FRAME-RACK	"	3
59	P0138S0100	ASSY LED LAMP	LED BAR 468	1
60	P0138S0200	ASSY LED LAMP	LED BAR 910	1
61	P0185S0300	POWER SUPPLY (SMPS)	LPV-35-24	1
62	P0100S0500	CONDENSER	4 LINE 8 COLUMN	1
63	P0100S0600	CONDENSER	4 LINE 10 COLUMN	1
64	P0144S1300	PIPE SUCTION (47,70,91W)		2
65	P0100S0700	SUB-CONDENSER	ø4.76*ø200	1
66	P0168S0100	DRYER	DML 032S	2
67	P0199S0100	TIMER	T38N-03A	1
68	P0186S0100	RELAY	GMC-30P2 110V	1
69	30218B0300	FAN RADI	ø200 (SUCTION)	2
70	3.021E+09	BRACKET SUBORT (A)		2
71	PO109S0100	CAP DRAIN	PA-6	1
72	30275U0200	MAG STOPPER GRILL PLT		4
73	30206A4600	BRACKET MAGNET		4
74	30200Q1200	SAMSUNG COMPRESSOR	SK1A1C-L2W 115V	2
75	3.963E+09	MOTOR SHADED POLE	IS-4420DWSG-1	2
76	4VMOA15630	CUSH FAN-MOTOR FIXR		4
77	30213A1014	POWER CORD		1
78	30281Q0101	S/W LAMP		1
79	30283N0100	THERMOSTAT	GNF-107DC	1
80	P0127S0200	COMP WIRE	4P (SAMSUNG COMP)	2

17-1. TIDC-91 Decomposition Assembly Drawing

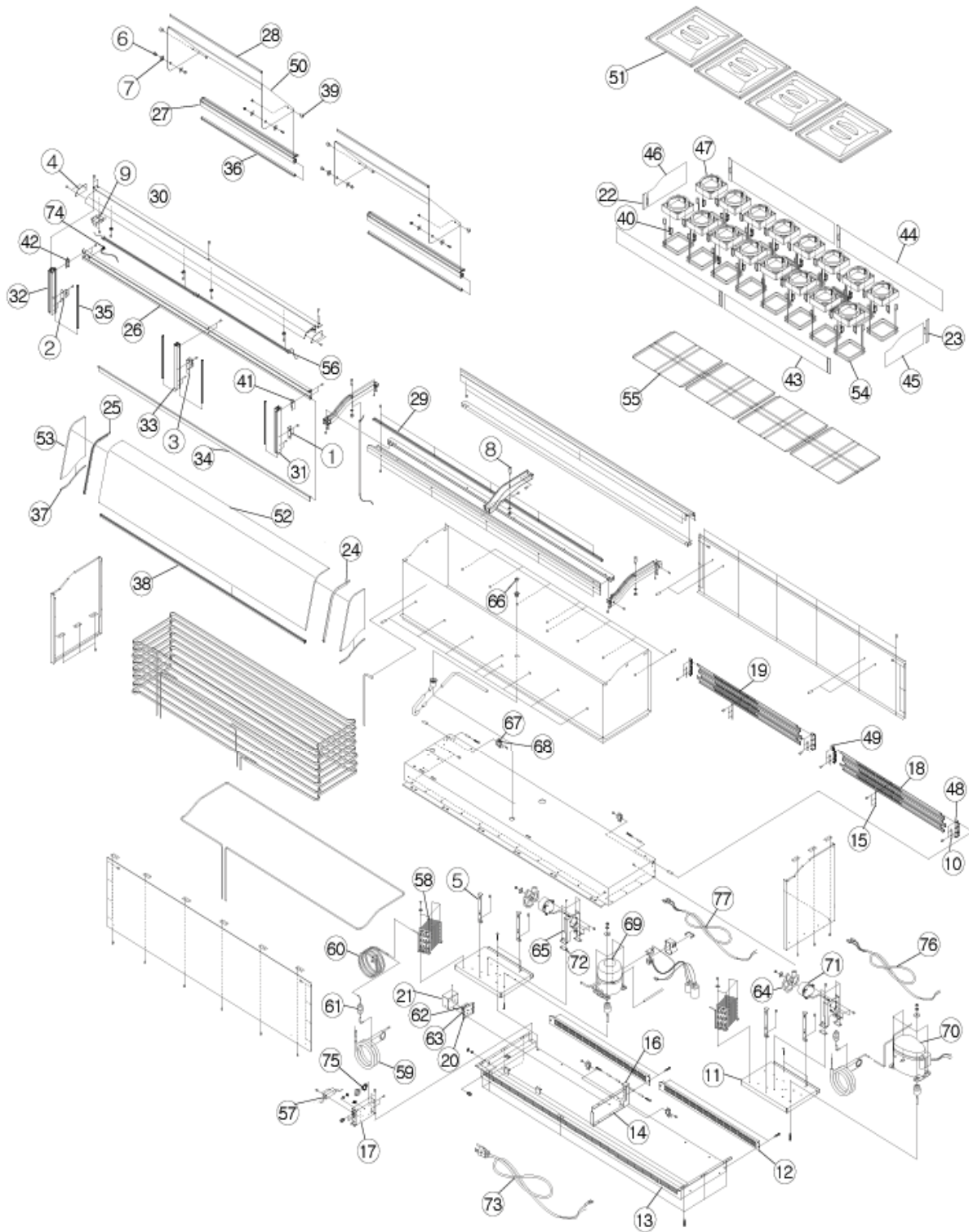

17-2. TIDC-91 Decomposition Assembly Drawing Component

NO	PART CODE	PART NAME	DESCRIPTION	Q'TY
				91W
1	P0106S0100	BRACKET HINGE*L	SUS-304 t1.5	1
2	P0106S0200	BRACKET HINGE*R	SUS-304 t1.5	1
3	P0106S0300	BRACKET HINGE*M	SUS-304 t1.5	1
4	P0114S0100	COVER LAMP*L*R	EGI t0.8	2
5	P0106S0400	BRACKET BODY		4
6	P0129S0100	HINGE DOOR*L*R	MSWR	2
7	P0129S0200	HINGE DOOR	AL	2
8	P0149S0100	INSERT POLE	MSWR	3
9	P0114S1900	COVER LAMP WIRE	EGI t0.6	1
10	P0145S0100	PLATE MAGNET GRILL	SPG t0.6	4
11	P0103S0200	BASE COMP	SPG t1.6	2
12	P0106S1000	BRACKET COMP BASE	SPG t2.0	2
13	P0100S0400	ASSY FRAME MECH		1
14	P0106S1200	BRK FRAME MECA	SPG t2.0	1
15	P0106S0700	BRACKET GRILL	SPG t1.0	2
16	P0106S0800	BRACKET GRILL*M	EGI t1.0	1
17	P0106S1300	CASE PCB	SPG t0.8	1
18	P0124S0400	GRILL PLATE*A (16CAN)	EGI t0.6	3
19	P0124S0500	GRILL PLATE*B (16CAN)	EGI t0.6	3
20	P0106S1900	BRACKET TIMER	SPG t1.0	1
21	P0114S2000	COVER TIMER	SPG t0.6	1
22	P0175S0100	HANDLE PAD MAGNET	SUS304 t0.8*154	3
23	P0175S0200	HANDLE PAD MAGNET	SUS304 t0.8*230	3
24	P0122S2200	FRAME WINDOW*L	AL	1
25	P0122S2300	FRAME WINDOW*R	AL	1
26	P0122S2700	FRAME WINDOW*B	AL 63.5*2279	1
27	P0126S0200	HANDLE DOOR	AL W*1080	2
28	P0122S2900	FRAME DOOR	AL W*1080	2
29	P0122S3300	FRAME BODY*B	AL W*2285	1
30	P0111S0500	CASE LAMP	AL W*2282.6	1
31	P0153S0100	POLE SUPPORT*L	AL W*382.5	1
32	P0153S0100	POLE SUPPORT*R	AL W*382.5	1
33	P0153S0200	POLE SUPPORT*M	AL W*382.5	1
34	P0123S0400	GASKET DOOR	PVC W*2278	1
35	P0123S0500	GASKET DOOR*S*L*R	PVC W*382	4
36	P0123S0700	GASKET HANDLE	PVC W*1084	2
37	P0123S0900	GASKET WINDOW*S*L*R	PVC W*280	2
38	P0123S1400	GASKET WINDOW*U	PVC W*2262	1
39	P0152S0100	STOPPER DOOR*L*R	RUBBER	4
40	P0107S0200	BUSHING CAN COVER	RUBBER	32
41	P0114S2000	COVER FRAME WIN*L	RUBBER	1
42	P0114S2100	COVER FRAME WIN*R	RUBBER	1
43	P0141S1400	PAD MAGNET*F	M.P 154*1090	2
44	P0141S2000	PAD MAGNET*B	M.P 230*1090	2
45	P0141S1500	PAD MAGNET*L	M.P 230*526.5	1
46	P0141S1600	PAD MAGNET*R	M.P 230*526.5	1
47	P0114S2200	CAN COVER	ABS	16
48	P0130S0100	HOLDER GRILL PLT*L	NYLON 6	2
49	P0130S0200	HOLDER GRILL PLT*R	NYLON 6	2
50	P0117S0200	DOOR	PC t4.5	2
51	P0114S2300	COOLING COVER	ABS t2.0	4
52	P0155S0400	WINDOW	GLASE t6.0	1
53	P0155S0500	WINDOW*S*L*R	GLASE t6.0	2
54	P0178S0100	WIRE RACK*A	WIRE	16
55	P0178S0200	FRAME-RACK	"	4
56	P0138S0200	ASSY LED LAMP	LED BAR 910	2
57	P0185S0400	POWER SUPPLY (SMPS)	LPV-35-24	1
58	P0100S0600	CONDENSER	4 LINE 10 COLUMN	2
59	P0144S1300	PIPE SUCTION (47,70,91W)		2
60	P0100S0700	SUB-CONDENSER	ø4.76*ø200	1
61	P0168S0100	DRYER	DML 032S	2
62	P0199S0100	TIMER	T38N-03A	1
63	P0186S0100	RELAY	GMC-30P2 110V	1
64	30218B0300	FAN RADI	ø200 (SUCTION)	2
65	3.021E+09	BRACKET SUBORT (A)		2
66	PO109S0100	CAP DRAIN	PA-6	1
67	30275U0200	MAG STOPPER GRILL PLT		4
68	30206A4600	BRACKET MAGNET		4
69	30200Q1200	SAMSUNG COMPRESSOR	SK1A1C-L2W 115V	1
70	30200R1100	FRANCE COMPRESSOR	CAE2420Z 115V	1
71	3.963E+09	MOTOR SHADED POLE	IS-4420DWSG-1	2
72	4VMOA15630	CUSH FAN-MOTOR FIXR		4
73	30213A1014	POWER CORD		1
74	30281Q0101	S/W LAMP		1
75	30283N0100	THERMOSTAT	GNF-107DC	1
76	P0127S0100	COMP WIRE	2P (FRANCE COMP)	1
77	P0127S0200	COMP WIRE	4P (SAMSUNG COMP)	1